

ITCA 

ITALIAN TRADE AGENCY
ICE - Italian Trade Commission
Trade Promotion Office of the Italian Embassy



FEDERAZIONE NAZIONALE
IMPRESSE ELETTROTECNICHE
ED ELETTRONICHE



CONFININDUSTRIA

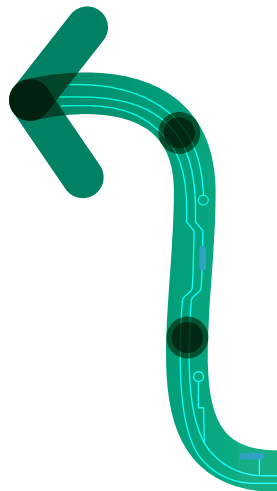

MIDDLE EAST ELECTRICITY SOLAR MIDDLE EAST

11 - 13 February 2014

Dubai International Exhibition & Convention Centre

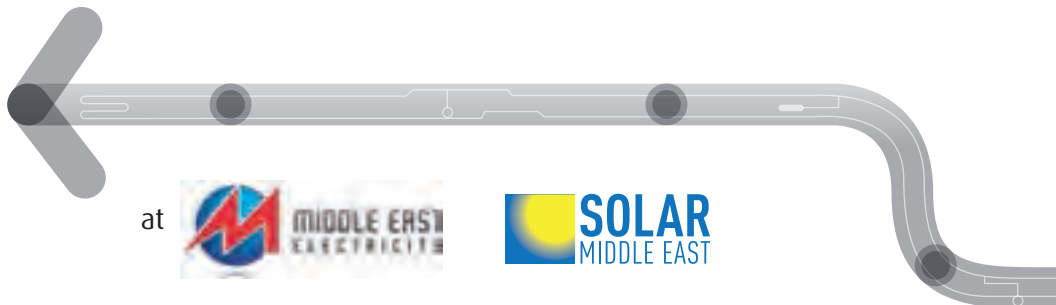

at



ITALIAN COMPANIES AT MEE &

FLOOR PLAN HALL 3

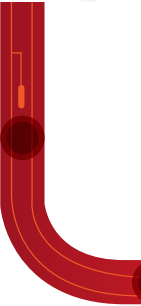
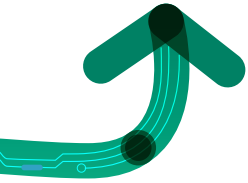

	3C39
	3C37
3C30	3C31

3A28	3A29
3A20	
	3A21

3B28	3B29
3B24	3B25
3B20	3B21

3C28	3C29
3C26	-----
	3C25
3C20	-----
	3C21

3D28	3D29
3D24	3D25
3D20	3D21

3A19	
3A16	3A17
3A12	3A13
3A10	3A11

3B18	3B19
3B14	3B15
3B10	3B11

ICE - ANIE 3C18	3C19
	3C13
3C10	3C11

3D18	3D19
3D14	3D11
3D10	

SME 2014

S1G19	S1G18	S1G17
-------	-------	-------

SHEIKH SAEED HALL

S1G20	
S1G22	S1G23
	S1G25
S1G26	S1G29
S1G28	



SHEIKH MAKTOUM HALL

3E18	3E19
3E14	3E15
3E10	

MB20	MB21
------	------

TABLE OF CONTENTS

STAND N°	COMPANY NAME	PAGE
	Letter from the Ambassador of Italy to the UAE	2
	Letter from the Vice President of ANIE for Internationalization	3
3C18	ITALIAN TRADE COMMISSION	4
3C18	FEDERAZIONE ANIE	5
	PROMOS - Special Agency of the Milan Chamber of Commerce	6
3A10	AB TRASMISSIONI S.r.l.	8
3C25	ADEL SYSTEM S.r.l.	9
MB20	ALBASOLAR S.r.l.	10
3C29	ALFA ELECTRIC	11
3B24	ALTATENSIONE - PAN INTERNATIONAL S.r.l.	12
3D18	ARISTONCAVI GULF DISTRIBUTION LTD	13
3C13	BF S.r.l.	14
3A28	BONOMI EUGENIO S.p.A.	15
3D25	BORRI	16
3C20	BREMAS ERSCE S.p.A.	17
3A29	BRUNO S.r.l.	18
3C31	CANALPLAST S.p.A.	19
MB21	CAPPELLO ALLUMINIO S.r.l. - Consorzio COEXPORT	20
3D29	CARPANELLI MOTORI ELETTRICI S.p.A.	21
S1G23	CGS Instrument Transformers S.r.l.	22
3D28	CO.SI.ME. S.r.l.	23
3E10	COELMO spa	24
3C37	COMAR CONDENSATORI S.p.A.	25
3B15	CORTEM MIDDLE EAST FZCO	26
3E15	DUCATI ENERGIA S.p.A.	27
3D24	EL.CO. S.r.l.	28
3E14	ELCA S.r.l.	29
3A20	ELCON MEGARAD S.p.A.	30
S1G17	ELEMATIC - ITW Construction Products Italy S.r.l.	31
3B28	ELETTROMECCANICA PIOSSASCO S.r.l.	32
3A17	FABBRICA TRENTINA CONDUTTORI S.r.l.	33
3A11	FEAM S.r.l.	34
3A19	FINDER S.p.A.	35
3B18	FRER S.r.l.	36
3C19	GBE S.p.A.	37

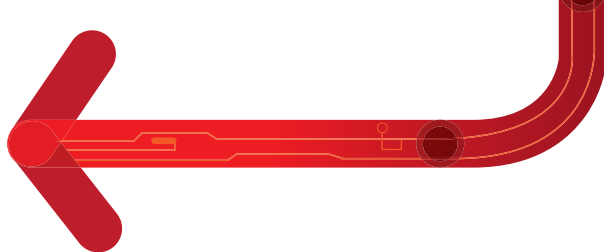

TABLE OF CONTENTS

STAND N°	COMPANY NAME	PAGE
3C10	GIOVENZANA INTERNATIONAL B.V.	38
3C30	GRUPPO ENERGIA S.r.l.	39
3D14	H-OLD S.p.A.	40
3B10	ICAR S.p.A.	41
3C26	IMEQUADRI DUESTELLE S.p.A.	42
3A12	IMQ - Istituto Italiano del Marchio di Qualità	43
3D10	IREM S.p.A.	44
3D20	ITALWEBER S.p.A.	45
3B21	LA TRIVENETA CAVI S.p.A.	46
3B20	LANZINI & C. S.r.l.	47
3B19	LAYER ELECTRONICS S.r.l.	48
S1G18	LEVER S.r.l.	49
3D11	LOVATO ELECTRIC S.p.A.	50
3C28	MARLANVIL S.p.A.	51
3C39	MT MILANTRACTOR S.p.A.	52
S1G28	NEW AREL S.r.l.	53
S1G29	NUOVA SACCARDO MOTORI S.r.l.	54
S1G19	OREFICE S.r.l.	55
3B11	ORTEA S.p.A.	56
S1G26	PERIN GENERATORS GROUP	57
3D19	PIZZATO ELETTRICA S.r.l.	58
3C21	QUADRITALIA S.r.l.	59
3E18	RODA CAVI S.r.l.	60
3A13	ROSI Electrical Products	61
3E19	SAER ELETTROPOMPE S.p.A.	62
3A16	SELTA S.p.A.	63
S1G22	SICES S.r.l.	64
S1G20	SINCRO - brand of SOGA S.p.A.	65
3B29	SPARK ENERGY S.r.l.	66
S1G25	TAPPI STAMPATI S.r.l.	67
3A21	TEAFLEX S.p.A.	68
3B14	TEKNOMEGA S.r.l.	69
3C11	THYTRONIC S.p.A.	70
3D21	VEMER S.p.A.	71
3B25	WORK ITALIA S.r.l.	72

LETTER FROM THE AMBASSADOR OF ITALY TO THE UAE



*The Embassy of Italy
to the United Arab Emirates*

pag. 2

With high safety, efficiency, quality and environmental compatibility standards, the products and services of Italian electro-technical and electronic manufacturers fulfill today's global requirements, even under demanding geographical conditions. Customers can expect reliable, target-oriented and custom-tailored solutions, and a high rate of innovation. Visiting the Italian Pavilion at Middle East Electricity and Solar Middle East 2014 will represent an excellent opportunity to create business relations and new commercial and industrial openings, between local partners and reliable Italian exhibitors; it is also an ideal platform for the dialogue of companies with their partners from Dubai, from the entire UAE, as well as from other GCC countries: with the increasing demand connected with the need for energy of Middle Eastern and Africa Countries, this Fair is the ideal showcase in the entire region for all the Italian companies of the electro-technical and electronic sector. Moreover, the exploitation and development of renewable energies are among the fundamental themes of modern society, taking into account the environmental and socio-economic implications. These exhibitions want precisely to highlight, among international trading and institutional operators, the potential of our Made in Italy in developing the industry. The ultimate goal is to set up both international co-operation aimed at increasing long-term competitiveness of Italian firms, and to draw the attention of foreign investors to our country. The Italian technologies will compete and bring added value to the the vibrating environment that Dubai will breath in these years preparing the Expo 2020. As a matter of fact, the Italian Trade Commission, Trade Promotion Office of the Italian Embassy, in co-operation with Federazione ANIE and under the auspices of the Embassy of Italy to the UAE, supports again this year the official Italian participation with more than 60 companies attending the 39th year edition of Middle East Electricity and Solar Middle East, the largest power & electricity exhibition in the entire region, which will take place from February 11th to 13th at the Dubai International Exhibition Centre.

A handwritten signature in black ink, reading "Giorgio Starace".

Giorgio Starace

Ambassador of Italy to the UAE

LETTER FROM THE ANIE VICE PRESIDENT FOR INTERNATIONALIZATION

Middle East Electricity represents the leading exhibition for energy industry in the Middle East region and ANIE strongly supports the Italian official participation to the 39th edition. ANIE has been representing the Italian electrical engineering and electronic industry since 1945. With a global turnover of 63 billion euro in 2012, the Italian technology industry has always been focused on innovation, making up over 30% of private Italian investment in R&D. The key technologies represented by ANIE shape the innovation rates of strategic economic and industrial sectors as energy, construction, communication and transport.

The geographical position of the UAE is strategic as a bridge between Europe and Asia. In the current economic outlook, Middle East region remains one of the most vigorous market thanks to strong infrastructural investments and a growing demand for private consumption.

Today networking is crucial for Italian companies presenting themselves on global markets. ANIE actively supports the growth and the competitive potential of electrical and electronic companies worldwide.

The participation at MEE 2014 represents a great showcase of Italian high tech manufacturing excellence from a value chain perspective. Italian industry has the expertise to provide the most innovative technological solutions that the global market needs and that we aim to highlight at Middle East Electricity 2014.



Andrea Maspero

ANIE Vice President for Internationalization



FEDERAZIONE NAZIONALE
IMPRESE ELETTROTECNICHE
ED ELETTRONICHE



CONFINDUSTRIA



The Italian Trade Agency-ICE is the Government agency that supports the globalization of Italian firms, under the strategies of the Ministry of Economic Development. ICE helps to develop, facilitate and promote Italian economic and trade relations with foreign countries, focusing on the needs of SME, their associations and partnerships. ICE sustains Italian firms in their internationalization processes and promotes worldwide the marketing of Italian goods and services, Italian investments, as well as the image of "Made in Italy" products around the world. ICE provides also information, support and consultancy to Italian companies on foreign markets, promoting and fostering export and cooperation in all areas with the target of increasing and make more effective their presence on international markets.

ICE works closely with the Italian Regions, the network of the Italian Chambers of Commerce, business organizations and other public and private entities.

ICE headquarters are in Rome, with a large network of offices around the world which are "Trade Promotion Offices or Sections" of the Italian Embassies or Consulates.



ITALIAN TRADE AGENCY

ICE - Italian Trade Commission
Trade Promotion Office of the Italian Embassy

Visit us at
Stand 3C18

ITALIAN TRADE COMMISSION

Sheikh Zayed Road - Dubai Internet City - ARENCO Tower, Office 506 - 500088 Dubai, U.A.E.
Tel. +971 4 4345280 - Fax +971 4 4220983
dubai@ice.it - www.ice.gov.it www.italtrade.com

Federazione ANIE is a Confindustria member representing the Electrical and Electronic Engineering Manufacturing companies operating in Italy. ANIE is an active and recognised interlocutor of the stakeholders who influences framework policies in Italy and abroad and offers to Member Companies a platform where they can confront with a whole community of industries.

ANIE, with over 1,200 member companies, represents the following Industry sectors: Power Production including Photovoltaic technologies, Power Transmission and Power Distribution, Electrified Transports, Lift and Escalators, Lighting, Cables, Components and Devices for Electrical Installation, Household Appliances and Catering Equipment, Electronic Components, Automation and Instrumentation, Security, Fire Safety and Building Automation, Motion and Power Transmission Systems.

ANIE industry in figures for 2012:

- 63 billions € of global turnover
- 29 billions € of export (52.9% on global turnover)
- 425,000 employees



FEDERAZIONE NAZIONALE
IMPRESE ELETTROTECNICHE
ED ELETTRONICHE



Visit us at
Stand 3C18

FEDERAZIONE ANIE - Viale V. Lancetti, 43 - 20158 Milano (MI) - Italy
Tel. +39 02 3264.397 - Fax +39 02 3264.212
internazionale@anie.it - www.anie.it - www.italiantech.com
Contact - Mariarosaria Fragasso, Devis Friso



PROMOS

pag. 6

Special Agency of the Milan Chamber of Commerce

Promos is the Special Agency of the Milan Chamber of Commerce which supports small and medium-sized enterprises in their international business. With more than twenty-year experience and its close cooperation with trade associations and companies, Promos has a good understanding of companies' needs in their dealings with overseas markets. Promos can offer these companies help and advice so they can face up to the challenges of the global market.

Promos works synergically with the main institutional players and associations to support companies in the internationalisation process.

Promos network, stretching in strategic international areas, has a deep understanding of overseas markets in order to provide specific services based on company needs.



PROMOS - SPECIAL AGENCY OF THE MILAN CHAMBER OF COMMERCE

Via Camperio, 1 - 20123 Milano (MI), Italy

Tel. +39 028515.5375 - Fax +39 028515.5227

sergio.cacopardo@mi.camcom.it - www.promos-milano.it

Contact - Sergio Cacopardo

LOCAL OFFICE IN Abu Dhabi – EAU

c/o Executive Business Center - Bin Arar Tower, Najda Street

PO Box: 112358 - Office: M11-M12 - Abu Dhabi, UAE

Tel. +971 2 495.2783 - Fax +971 2 6740066

deskeau@mi.camcom.it

Contact - Cesare Maraglio

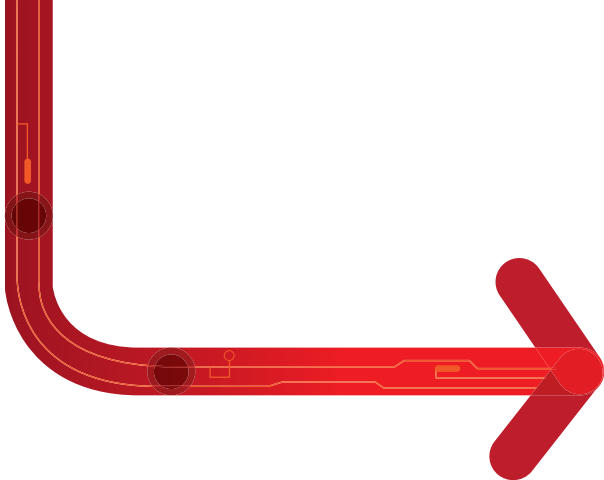

ITCA

ITALIAN TRADE AGENCY
ICE - Italian Trade Commission
Trade Promotion Office of the Italian Embassy



FEDERAZIONE NAZIONALE
IMPRESE ELETTROTECNICHE
ED ELETTRONICHE



CONFINDUSTRIA



MIDDLE EAST ELECTRICITY SOLAR MIDDLE EAST

11 - 13 February 2014

Dubai International Exhibition & Convention Centre

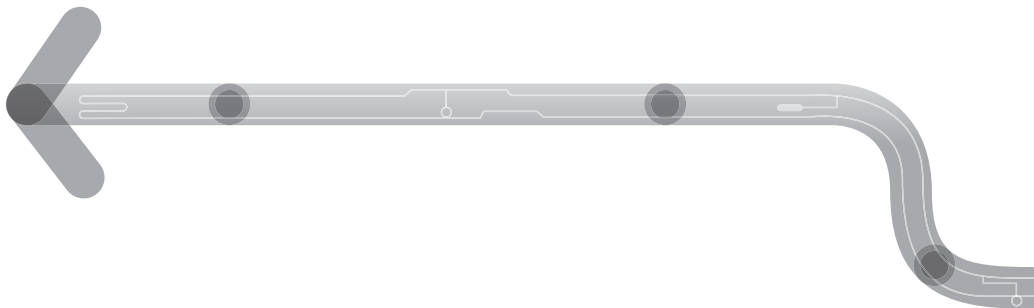
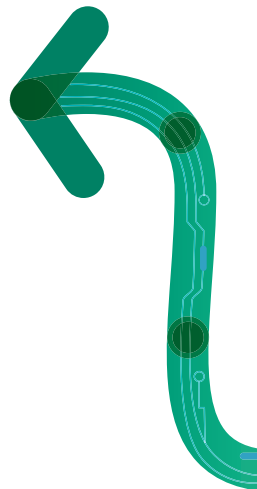

AB Trasmissioni designs and manufactures a vast range of flexible couplings, which meet all mechanical coupling requirements within the most diversified application fields. For each series of couplings we offer a wide and well structured range of products that gives our customers, distributors and service centres a useful interchangeability among the components of the different series. Thanks to its 30 years experience in the field, AB Trasmissioni can develop an engineered and customized product according to suit specific customer's needs. Our couplings are made with high quality cast iron and they undergo static balancing and testing by means of computerized three-dimensional control with certification system. An advanced constructional technology ensures a high quality standard and, at the same time, the highest flexibility in terms of production in order to satisfy our customers, whatever the quantity they require may be. Our flexible couplings can be employed within the most diversified application fields, such as mechanical transmissions in general, motor applications, agriculture, irrigation, building industry.

Products:

Flexible Couplings, Automatism, Components For Diesel Engines.





Founded in 1991, **ADEL system** develops and manufacture industrial linear and switch-mode power supply units and it is recognized as one of the world's leading manufacturer of industrial power supplies, DC UPS and intelligent battery chargers. In this period it grew steadily, quickly acquiring a strong reputation for its high standards of quality and reliable products. Today the ADEL system net-sales involves many companies in the worldwide. With our experience and more than 250 models produced for different applications, today we offer a range of power supply units designed to meet the requirements of all applications in the field of industrial automation.

Products:

FLEX Power Supplies, CB Battery Chargers, DC-UPS, Battery Modules.



Visit us at
Stand MB20

pag. 10

Albasolar is an Italian company leader in design, manufacture, construction and installation of “turnkey” photovoltaic systems. Thanks to this experience Albasolar is a leading Italian EPC with more than 100 MW of installed.

Albasolar designs and manufactures its own products, as a driving force in new market trends to offer all its clients a wide range of products increasingly in line with end clients needs and requirements. Our range included: photovoltaic systems for off grid and on grid situation, solar thermal systems, wind energy systems, panels, blacksun façade.

Products:

Stand Alone System, Power station, Photovoltaic Facade Blacksun, Photovoltaic Modules, Inverter.



ALBASOLAR S.r.l. - Corso Barolo, 15 - 12051 Alba (CN) - Italy
Tel. +39 017 3285882 - Fax +39 017 3283069
commerciale@albasolar.it - www.albasolar.it
Contact - Andrea Troja



Visit us at
Stand 3C29

pag. 11

ALFA ELECTRIC was established in 1973 in Carate Brianza, near Milan, Italy, Since the early '90s, we have been developing and manufacturing innovative products in the field of thermal management, especially ventilation, heating, Air conditioning units and accessories for electric enclosures.

Products:

Air conditioning, Ventilation, Heating, Control, Lighting, Accessories.

A decorative horizontal bar spans the width of the page, featuring several icons: a circle, a square with a dot, a square with a horizontal line, a circle, and a square with a horizontal line. On the right end of the bar is a large, grey, stylized arrow pointing to the right.

ALFA ELECTRIC - Via della Valle, 39 - 20841 Carate Brianza (MB) - Italy
Tel. +39 0362 903539 - Fax +39 0362 975133
info@alfaelectric.com - export@alfaelectric.com - www.alfaelectric.com
Contact - Claudio Garavasso, Alessandro Maturo

PAN INTERNATIONAL was founded in 1987 and it is located in FLORENCE, ITALY. Through its 3 different brands PAN, SIBILLA Led and ALTATENSIONE, it is capable of meeting all lighting technology needs.

ALTATENSIONE dedicates important resources to R&D, it is able to offer architectural lighting solutions designing all its lighting products in-house with unmatched reliability. A qualified and dynamic staff will support you for the development and realization of any lighting projects, to be a reliable Italian partner.

PAN-ALTATENSIONE thanks to 25 successful years in Italian market, now intends to develop EXPORT BUSINESS offering innovation, service and quality.

Products:

Architectural led equipments and fittings, Led commercial light fixtures, Decorative light fixtures for outdoor an indoor.





ARISTONCAVI

Visit us at
Stand 3D18

pag. 13

ARISTONCAVI S.p.A. is one of the major independent Italian manufacturer Company of electrical rubber cables both low and medium voltage for special applications in various segments such as: airports , railways , roads, tunneling, ports and container terminals, mining, open cast, oil and gas, wind turbine, water treatment and irrigation, leisure facilities, and commercial sectors and power substation.



Products:

Rubber cables for general application and installation as well as for special applications and certified products for water pumps, waste and drinking water, renewable energy, inverters, and tailored and customized cables design for meet customer special requirements.

ARISTONCAVI GULF DISTRIBUTION JLT

P.O.Box 487628 JBC 2, Floor 35, Office 04 – Dubai – U.A.E.

Tel. +971 4 4539744 - Fax +971 4 4539745 - a.prola@aristoncavi.com

m.gharaibeh@aristoncavi.com - f.dsouza@aristoncavi.com - www.aristoncavi.com

Contact - Aleksander Prola



BF produces winding machines for distribution and power transformer as:

- › Foil winding machines for low-voltage
- › Foil winding machines for high-voltage for cast resin transformers
- › Wire winding machines for low and high-voltage
- › Vertical winding machines for power transformers
- › Horizontal winding machines for power and distribution transformers
- › Core cutting lines
- › Corrugated walls production lines

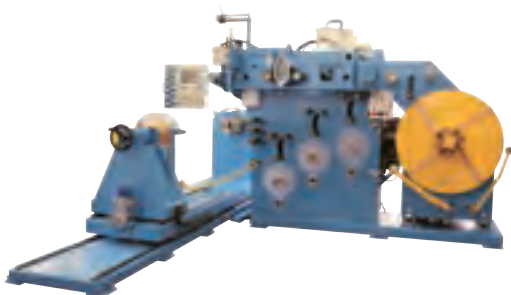



Bonomi Group manufactures industry leading solutions and components for the Power Transmission, Power Distribution and Rail electrification markets worldwide. **EB REBOSIO:** Developing and Producing world class Composite insulators for more than 50 years Injecting Silicone Rubber in a High Temperature Vulcanised process ensures highly resilient bonding of all insulator components. New brand in the group is **ISOELECTRIC** widening thus the range of new products like Epoxy Resin insulators, Bushing insulators, surge arresters and cut outs. **BONOMI EUGENIO:** A European leader in electrical connectivity delivers a wide range of solutions and components for overhead line equipment: low weight, high strength assemblies and components in Copper, Copper Alloy, Aluminium Alloy and steel; Mechanical clamps and compression fittings; Railway solutions including droppers, tensioning devices and cantilevers.

Products:

HTV Insulators for High & Medium voltage - Line & substation post insulators - Epoxy resin insulators / Bushing insulators / surge arresters / cut outs - Omnia - patented & homologated cantilevers Railways for standard & high speed / urban transport (3kV -25kV) - Railways Droppers / tensioning devices / electrical connections / Clamps.

BONOMI EUGENIO S.p.A. - info@bonomieugenio.com

EB REBOSIO S.r.l. - info@ebrebosio.it

Tel. +39 030 9650304 - Fax +39 030 962349 - www.bonomi.net

Contact - Ziad Samaha, Diego Bonomi

Borri is a company specializing in the custom design, manufacture and support of systems for the power protection in the industrial and ICT sectors. Based in Italy with 12,000 m² of production space and a large full-testing area, the company can call on more than 80 years of experience and multidisciplinary research and development, one of the most complete as regards the different disciplines in the field of power conversion. Borri has a leading position in the oil and gas market thanks to its proven customising expertise and continuous pursuit of excellence in a state-of-the-art product. However, wide experience in several branches of power electronics such as UPS systems for data centres and inverters for renewable energy and storage, make Borri a leader in this technology not only for oil and gas applications. Borri S.p.A. has a strong presence in all five continents where it can provide on- site service and technical support. **For more info visit: www.borri.it**

Products:

Uninterruptible Power
Supply Systems
Accumulators & power
Electronics.



ERSCE

BREMAS ERSCE S.p.A. was formed by the merger of two well established brand names: Bremas and Ersce.

These Companies are two major players in the design, manufacturing and marketing of electromechanical components for the industrial automation with a complete range of cam switches, disconnecter switches and limit switches able to satisfy the most different fields of applications. With over 50 years of experience in design and manufacturing, Bremas Ersce is a leader in the industrial sector for standard and custom products.

Products:

Cam Switches: a wide range of diagrams from 12 up to 630 Amperes

Disconnecter Switches: from 20 up to 1600 Amperes

Limit and Safety Switches: a broad range of actuators suitable for multiple applications.

BRUNO S.r.l., ISO-certified manufacturer of generating sets from 2 to 2500kVA, 50Hz and 60Hz, powered by CUMMINS, VOLVO, PERKINS, JOHN DEERE, DEUTZ. 3 production plants located in Italy manufacturing around 14.000 generating sets per year. LIGHTING TOWERS for professional use with LED and Metal Halide lights. New WHISPER BOX and WHISPER CUBE³ gensets series with electric radiators.



ADVANCED TECHNOLOGIES FOR TRUNKING SYSTEM



Canalplast is, since more than 38 years, a leading manufacturer of cable management systems and electrical installation material. We are ISO9001:2008 certified and RoHS-compliant, while our trunkings have UL, CSA and GOST approvals among others. We work with experience and dedication, offering high-quality solutions, also through the support of our certified laboratory. Canalplast exports to over 60 countries in the world, including the Gulf area.

Products:

Panel trunkings, DIN rails, halogen-free trunkings, air-conditioning trunkings, skirting and dado trunkings, Floor boxes & turrets, connectors, Junction boxes and fittings, enclosures, MCBs, CEE sockets.





Our Photovoltaic Business Division produces pv-modules characterized by high efficiency and superior quality, made in Italy. Our automated production lines use the latest technologies for the production of pv-modules. Design and production of innovative Building-integrated photovoltaic systems BIPV. Cappello Energy is our company specialized in the design and installation of turnkey photovoltaic systems, result of continuous R&D of innovative solutions and synergy with the others companies of **Cappello Group**.

Products:

MICRON pv-modules www.micronsun.it, **COVERSUN** patented fully integrated modular roofing system and pv-carport www.coversun.it, **SUNWALL** pv-ventilated curtain wall.



CAPPELLO ALLUMINIO S.r.l. - Zona Industriale IV^ Fase Viale 3 - 97100 Ragusa - Italy

Tel. +39 0932 660211 - Fax +39 0932 660222

info@cappellogroup.it - www.cappellogroup.it

Consorzio COEXPORT - c/o Confindustria Zona Ind.le I Fase - 97100 Ragusa - Italy - www.coexportrg.it

Contact - Giorgio Cappello



Carpanelli Motori Elettrici S.p.A., founded in 1947 by Zeno Carpanelli, is a well-established Italian company for the planning and manufacturing of 3-phase and single-phase asynchronous induction motors. Up to 80% of the production of Carpanelli consists of special and customised motors, tailored around specific requests of its customers. Integrating all design and production phases within the plant – including 3D modeling of the mechanical components and electrical development with FEM – Carpanelli is nowadays able to answer to the needs of a wide-ranging customers portfolio, both in Italy and abroad. The motor you need? We have it!

Products:

Brake Motors, Atex Motors, Inverter Motors.

CGS Instrument Transformers with its new production site located in Monza, continues a long tradition started in 1896 by Eng. Camillo Olivetti, carried on afterward with the name Marconi Automazione and Alstom CGS. CGS Instrument Transformers is part of Alfa Standard Group, an Italian company present in the bus ducts field, since more than forty year, both in the national and the international market. CGS Instrument Transformers takes advantage of its know-how, resulting from more than forty years experience in manufacturing cast resin instrument transformers (current transformers up to 41,5 kV and voltage transformers up to 52 kV). Our instrument transformers work in the electric networks all over the world, both in outdoor plants and inside of electrical switchgear; in primary and secondary distribution networks, in HV transmission networks and in power plants; assuring the maximum protection against electrical fault and precision in measuring the electrical parameters. Our design and manufacturing process of instrument transformers guarantee the highest safety standards and the minimum environmental impact.



Current transformers

Products:

Current transformers for indoor, Current transformer for outdoor, Voltage Transformers single pole for indoor, Voltage Transformers double poles for indoor, Voltage Transformers for outdoor, Special Voltage Transformers.



Voltage transformers



CO.SI.ME. has been established in 1965, we are manufacturers of explosion proof equipment and components since 30 years. The success of our Company is based on strong roots. We are an old and modern Company, we derive our strength and driving force from this. Our headquarter, commercial office and factory are located in Milan, in the north of Italy. CO.SI.ME. winning formula has always been progress and innovation, superlative performance and intense motivation to be the market leader, that takes a great deal of ambition and vision. We want to inspire our customers for our products and services - through technology, perfection and service. Due to the continuous efforts and investments in our internal laboratory with the combination of undisputed skills acquired in the field since many years of activity, it makes of CO.SI.ME. an excellent example of "Made in Italy" in the world. CO.SI.ME. has the independence to be able to follow long-terms Company goals.

Products:

Explosion proof lighting fixture, Explosion proof push buttons, Explosion proof panels.

Coelmo spa is one of the oldest European Manufacturer of Diesel Generating Sets, having production facilities in Italy since 1946.

Coelmo spa designs and realizes Diesel Generating Sets from 3 to 3000 kVA for Commercial, Industrial, Oil & Gas, Marine and Telecom Applications.

With more than 60 years of experience, Coelmo is the preferred Diesel Generating Set Supplier for several leader companies in Construction, Telecom, Oil & Gas, Rental and Marine Industries.

Coelmo JLT is the Middle East Branch of Coelmo spa, managing the key accounts and the network dealers in MENA Area.

Products:

Diesel Generating Sets from 3 to 3000 kVA for Commercial, Industrial, Telecom and Oil & Gas applications.

Marine Diesel Generating Sets from 3 to 40 kW.

Hybrid Systems.



Full Hybrid System



Generating Sets from 3 up to 3000 KVA



Visit us at
Stand 3C37

pag. 25



COMAR Condensatori S.p.A., established in 1968, is a leading concern in design and development of a wide range of Capacitors and where Capacitors are in the main part especially to save electrical energy.

COMAR produces: single and three phase Capacitors for LV and MV applications, PF Regulators, filter reactors and a wide range of Automatic Cabinets included "detuned" type.

COMAR has experience in harmonics reduction by Passive and Active Filter systems. COMAR produces: AC/DC Filter, Damping and RC protection Capacitors. COMAR has a complete range for motor drivers, run and lighting Capacitors both in plastic and metal case.

COMAR has QSE Quality Integrated System Certified ISO 9001, 14001 and OHSAS 18001 and products approved with the Technical Standard by IMQ, VDE, C-UL-US and KEMA.

Products:

Lighting and Motor Capacitors, Three-Phase Capacitors, Racks, P.F Regulators, Reactors, P.F. Correction equipment for LV and MV application, Active and Passive Filters for Harmonics reduction.

COMAR CONDENSATORI S.p.A. - Via del Lavoro, 80 - 40056 CREPELLANO (BO) - Italy

Tel. +39 051 733383 - Fax +39 051 733620

export@comarcond.com - www.comarcond.com

Contact - Claudio Romagnoli

Cortem Middle East is Cortem Group's subsidiary for ME. Since 1968, Cortem has been designing and manufacturing explosion protected electrical equipment addressed to hazardous areas. Thanks to a continuous effort in technical innovation and improvement, today it's a leader in this field, able to provide a whole range of products, meeting on-shore and off-shore applications. Through its several branches, agents and distributor, it is able to support its clients both technically and commercially. Cortem Group electrical equipment are certified in accordance with the European standard ATEX and the International regulation IEC Ex, also obtained the certifications GOST for the Russian market.

Products:

Explosion-protected electrical equipment, Lighting fixtures, obstruction lighting fixtures, floodlights, hand lamps, Junction boxes, control stations, electrical fittings, cable glands, plugs and sockets, panel boards.

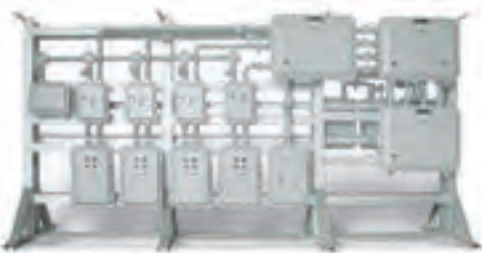

Ex Panel Boards



LED Ex Lighting Fixture



Ducati Energia was founded in 1926 and it's one of the most important companies around the Bologna area. The Group assets 6 worldwide plants featuring various fields of activities and a vast range of products such as the following: capacitors, power factor correction, power electronics, wind power generators, alternators and ignition systems, electrical vehicles and charging stations, energy analysers, electric network tele-control systems, railway signalling systems, ticket issuing and transport automation systems.

Products:

Medium and High Voltage Capacitor Banks for Power Factor Correction or Harmonic Filtering, Low and Medium Voltage enclosed Power Factor Correction equipment (Automatic or Fixed), Automation Equipment for MV and HV Energy Networks and for Transport Systems.



The **EL.CO.** company opened its doors for business in 1986, developing its own static relays with various power ratings, linear power supply units and switching gear, interfaces as well as analogue and digital temperature controllers. All company products are CE certified and the static relays have also acquired the VDE and the UL/CSA marks. The company has adequate productive equipment acquired to keep pace with the development in the sector. Thanks to its years of experience, the EL.CO. customer portfolio has leading accounts and the company is actively involved in both the national and foreign markets.

Products:

SMB170 - SMB171 SERIES STEP SOLID STATE RELAYS (BISTABLE)

ELTH17 / ELTH35 SERIES DIGITAL ELECTRONIC TEMPERATURE CONTROLLER





ELCA S.r.l. is one of the leading Italian company producing transformers, autotransformers and reactances, single and three phase, dry type, low voltage. Established in 1970 ELCA S.r.l. follows the goal of an ever wider range of products giving a great importance to quality; with this aim it is ISO 9001:2000 certified, is SASO Certified, has CE mark, UL/CSA homologation and UL/CSA insulation system homologation. Specialized in the production of items manufactured basing on technical drawings and particular needs of customer, ELCA S.r.l. is involved in different fields like automation, packaging, elevator, photovoltaic and lighting.

Products:

Transformers, Single And Three Phase, Autotransformers, Single And Three Phase, Reactances, Single And Three Phase.

Elcon Megarad is the Italian company that designs, produces, tests and markets power cable accessories and components for electrical networks worldwide. Our Research and Development department is ceaselessly active in developing innovative materials and technologies. Our laboratories for materials characterization and high voltage testing support the design of a comprehensive range of joints and terminations for all types of cables on the market, according to CENELEC, IEC, IEEE, and ASTM standards. Elcon Megarad is certified ISO 9001 and ISO 14001.

Products:

Heat shrinkable joints and terminations, cold shrinkable joints and terminations, resin joints and terminations, cable connectors and porcelain terminations, joints and terminations for special applications, as e.g. renewable energies and wind farms.



Elcon Megarad designs, manufactures, and supplies LV and MV power cable accessories of different technologies, as e.g. heat-shrinkable, cold-shrinkable, pre-molded, resin and tape based solutions.



Elcon Megarad manufactures and supplies components for applications on LV and MV power cables, as e.g. heat-shrinkable sleeves and molded parts, mastics, tapes, resins, cold-shrink tubes and components.



ELEMATIC - ITW CONSTRUCTION PRODUCTS ITALY S.r.l., as a producer of wiring and fixing systems, has been operating in the European market since the late 70's, becoming a leading company in his field. The offer is based on a complete and competitive range of products suitable for many electrical applications. Nowadays Elematic is part of the ITW Group, a worldwide manufacturer of highly engineered products and specialty systems with more than 100 years of history. Elematic: the strength of a great international Group combined with a focused and flexible identity.

Products:

Cable ties & Accessories, Cable connectors, Cable protection, Fixing Systems.

ELEMATIC - ITW Construction Products Italy S.r.l.

Head office: Viale Regione Veneto, 5 - 35127 Padova - Italy

Export department: Via Einstein, 28 - 35010 Cadoneghe (PD) - Italy - Fax +39 049 88 88 950
export.ecs@itw-italy.com - www.elematic.it - **Contact** - Silvia Scandilori, Caterina Bazza



Visit us at
Stand 3B28

pag. 32

Elettromeccanica Piossasco is a leading Italian manufacturer of MV/LV oil-filled, cast resin and dry type distribution transformers and autotransformers. Over 60 years of experience in the field together with the highest standard engineering make our company a reliable partner for customers all over the world.

We manufacture a wide range of standard transformers and we are also able to comply with customized models according to customer's requirements. Please visit our website at www.elpitalia.com/indexen.asp

Products:

Distribution HV/LV oil filled, Cast resin, Drytype transformers - autotransformers.



800KVA
Oil filled Transformer
Hermetical execution



1250KVA Cast Resin
Transformer



Visit us at
Stand 3A17

pag. 33

Established in 1999 **Fabbrica Trentina Conduttori S.r.l.** is today one of the leading Security Cables Producers in Europe. In 2008 joined the Group BERICA CAVI, one of the main cables producer in Italy. The BERICA CAVI Group is now able to provide a full range of special cables ,mostly IMQ, LPCB, UL TUV and now certified also ARAMCO. A wide range of cables including Security Cables, Fire Resistant Cables, CCTV and Coaxial Cables, Solar Cables, Shielded and Armoured cables, high and low temperature cables, instrumentations and Fibre Optic with components plus any kind of OEM cables made following the Customers requirement.



Since 2003 **Blumotix** designs and manufactures devices in KNX technology, always creating innovative KNX touch panels. With the advent of the smartphone Blumotix has expanded its activities with different applications able to control home & buildings through mobile devices. Since 2011 Blumotix has introduced in its catalog many different devices, such as actuators and interfaces for data, in order to provide its customers with a complete solution to their smart projects.

Products:

Special Cables, Solar Cables, Instrumentation Cables.

FABBRICA TRENTINA CONDUTTORI S.r.l. - Via Pineta, 21 B - 38068 Rovereto (TN) - Italy
Tel. +39 0464 480897 - Fax +39 0464 487700
info@fctsecuritycables.com - www.fctsecuritycables.com
Berica Cavi: Tel. +39 0444 820044 - sales@bericacavi.com - www.bericacavi.com
Sales Representation: sicevr@sice-cables.com
Contact - Davide Levi

Since 1961 **FEAM** is your partner for safety as leader manufacturer of customized explosion proof electrical equipment for Oil & Gas industry, for applications in zone 1/21 and 2/22, gas and dust environment. A global partner for our worldwide dealers in more than 45 countries with a team to support their activities either commercially either technically for on-shore and off-shore projects. FEAM is present in the Vendor List of major EPCs and Owners like Saudi Aramco, Saipem, KOC, KNPC, SABIC, ADCO, PDO, GASCO, TR, Petrofac, Shell, etc. Products are certified according to ATEX, IEC-EX, GOST-R, GOST-K, Inmetro. FEAM M.E., the regional branch office, is located in Jebel Ali free zone and stock is available.

Products:

Distribution boards, Control Panel, Switchcracks, Lighting fixtures, obstruction lighting systems and floodlights, Cable glands and complete range of accessories and fittings, Junction boxes, control station, Push button, Sockets, plugs and earthing systems.

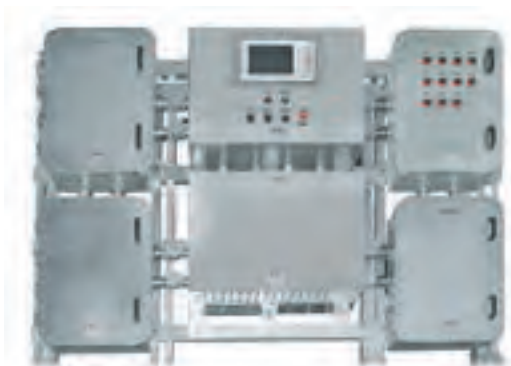



2014 - **Finder** celebrates its 60th anniversary. Since 1954 Finder marked the beginning of generations of products which to this day carry the distinguished brand. From more than 60 years Finder has worked in the field of relays and timers. Our high degree of specialization has produced over 10,000 different products (more than 300,000 relays a day) with one of the widest ranges available. Finder's headquarters are situated in Almese, North-West Italy. This company has been distributing its products through its branches and through its exclusive distributors around the world. 1954-2014 Relays to the core and much much more...

Products:

Finder has the widest range of world-wide quality approvals of any relay manufacturer.

SWITCH: plug-in general purpose relays; power relays; miniature and sub-miniature p.c.b. relays; relay interface modules; relay sockets and accessories.

CONTROL: timers; monitoring relays; surge protection devices; energy meters.

RESIDENTIAL AND COMMERCIAL: step relays; PIR's; chronothermostats and light dependent relays.

FINDER S.p.A. - Via Drubiaglio, 14 - 10040 Almese (TO) - Italy

Tel. +39 011 9346211 - Fax +39 011 9359079

s.michelotti@findernet.com - export@findernet.com - www.findernet.com

Contact - Serena Michelotti

FRER S.r.l. was founded in 1980 with the aim to manufacture high level reliability measuring electrical instruments and accessories to be used in distribution and control switchboards. Since its foundation Frer has been able to evolve and grow constantly thanks to its dynamic and enterprising workmanship.

The wide 30 years market experience permits Frer to offer:

- › Complete measuring instruments range
- › Fast deliveries
- › Homologation and Vendor List
- › Sales representatives and Distributors
- › International Certifications

Products:

Network Analysers, transducers, energy meters, earth leakage relays, current transformers, analog panel meters.



Frer products



Visit us at
Stand 3C19

pag. 37



GBE S.p.A. is an Italian Leading Manufacturer of cast resin and dry type transformers for any kind of application from 10 kVA up to 30 MVA for LV and HV up to insulating class 52kV and oil filled transformers from 50 kVA up to 50 MVA, 145 kV (BIL 650 kV). Furthermore GBE S.p.A. is able to offer a wide range of requirements for special units, i.e. shunt, current limiting, damping, tuning (filter), arc-suppression, smoothing reactors and earthing transformers, transformers for 6-12-18-24-36 pulse converters, HV-HV transformers, three-single phase transformers, triple windings transformers, Scott type transformers, start motor transformers and autotransformers.

Products:

Cast Resin Transformers and Reactors, Oil Filled Transformers and Reactors, Dry Type Transformers and Reactors.

GBE S.p.A. - Via Teonghio, 44 - 36040 Orgiano (VI) - Italy
Tel. +39 0444 774334 - Fax. +39 0444 775294
info@gbeonline.com - www.gbeonline.com
Contact - Giampaolo Mattiello





Visit us at
Stand 3C10

pag. 38

An ISO 9001 and ISO 14001 certified Company and with 60 years of experience, **Giovenzana International B.V.** is the leader in electrical control accessories such as cam switches, push buttons, conductor rails, limit switches, and others products.

Giovenzana is a reference point for Lift equipment qualified and specialized in Crane accessories, technology and Automation components.

Products:

Pendant stations, foot switches, buttons, Limit switches, Cam switches, disconnecter switches, Trolley Line.

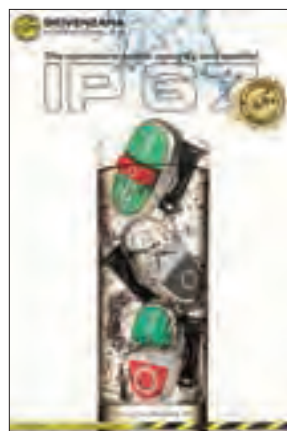

GIOVENZANA INTERNATIONAL B.V.

giovenzana@giovenzana.com - www.giovenzana.com

Contact - Massimo Giovenzana



Gruppo Energia S.r.l. a dynamic Italian company specialized in manufacturing electric capacitors with applications in the following fields:

- › single and three phase induction motor run capacitors
- › lighting capacitors for fluorescent and high pressure mercury vapour lamps
- › power factor correction capacitors for LV and MV
- › power electronic capacitors
- › power factor regulators & capacitor duty contactors

Gruppo Energia S.r.l. comes to the market with its strong range of products, providing customized solutions in order to satisfy all the customer's needs.

Quality, reliability and competence are ingrained in the company spirit, guaranteeing optimum organization, a flexible production process and rigorous systems to control the set targets.

Products:

Power Factor Correction Capacitors & Components For Lv & Mv, Motor & Lighting Capacitors, Power Electronics Capacitors, Power Factor Correction Banks.



h-old[®]

Visit us at
Stand 3D14

pag. 40

H-old S.p.A. Italian Manufacturing company of pressure sensitive adhesive tapes for electrical and industrial applications. UL approved products, exporting to all major countries in Europe and overseas. ISO 9001, ISO 14001 and OHSAS 18001 certified.

Products:

Single and double sided adhesive tapes based on different kind of supports such as PET film, glass cloth, PI film, Nomex[®] aramid paper, Aluminum and copper foil, PE foam combined with solvent based acrylic, modified acrylic and silicone adhesive.



H-OLD S.p.A. - Via Valsesia, 96/98 - 28061 Biandrate (NO) - Italy
Tel. +39 0321 838833 - Fax +39 0321 811322
info@h-old.com - www.h-old.com
Contact - Sergio Verderi, Elena Bottigelli



ICAR S.p.A. is one of Europe's leading capacitor specialists and bases its reputation on over 60 years of experience in the design, development and production of high performance polypropylene Capacitors. In order to have the control of the process from the base polypropylene film onwards to the finished capacitor, ICAR has also developed its own film manufacturing and metallization facilities.

Products:

Low Voltage Automatic and Fix Power Factor Correction Banks, Low Voltage Power Capacitors, Medium and High Voltage Power Capacitors and Banks, Reactive Power Factor Correction Controllers, Harmonic Blocking Reactors, Motor run and lighting capacitors, Power Electronics capacitors, Energy storage and pulse capacitors.

Imequadri Duestelle is part of IME S.p.A. Group and its headquarter is based in Ugnano (BG) near Milan, in a factory of more than 25,000 sqm (16,000 sqm indoor). Here are located sales, technical offices and production plants, with metalsheet forming, mounting, wiring departments, prototypes laboratories and testing rooms. Imequadri Duestelle is certified ISO 9001:2008 and ISO14001:2004 and the first ISO certification dates back to 1993.

Products:

The Switchgear Division designs and produces:

Low Voltage switchgears

Power Centers Polimeta,
 Motor Control Centers Multicontrol,

Medium Voltage switchboards

Metal Clad LSC2B-PM class of the Normoclad Series,
 Metal Enclosed LSC2A-PI class with air insulated LBS of the Rotobloc Series,
 Metal Enclosed LSC2A-PM class with SF6 insulated LBS of the Minibloc-6 Series

MV and LV Buducts Normoduct Prefabricated substations

The Equipment Division projects and manufactures:

indoor MV Load Break Switches and Disconnectors (Air or SF6 gas-insulated),
 Circuit breakers,
 Earthing Switches for panel/wall mounting solutions.



Normoclad
 MV Metal clad switchboard



Multicontrol
 LV Motor control center switchboard



About us

IMQ is Italy's most important certification body and a European leader in conformity assessments and laboratory tests for the electrical, electronic and gas industries.

Accreditations

We are a certification body accredited by Accredia. All our laboratories are accredited according to the ISO/IEC 17025 standard.

International agreements

We are a member of the CB scheme and a signatory to numerous certification agreements in force with foreign certification bodies.

Figures

18.000 Certified companies

140.000 Certified products

IMQ - ISTITUTO ITALIANO DEL MARCHIO DI QUALITÀ

Via Quintiliano, 43 - 20138 Milano - Italy - Tel. +39 02 50731 - Fax +39 02 50991550

mercati.esteri@imq.it - www.imq.it

Contact - Giuseppe Sonzogni, Fulvio Giorgi

IREM S.p.A., established in 1947, specializes in designing and manufacturing voltage stabilisers (AVR) and line conditioners for demanding applications like broadcast, telecommunication, electromedical appliances, industrial plants, construction, oil and gas, mining; luminous flux regulators (stabilised dimming systems) for energy saving and enhanced management of lighting plants; micro hydroelectric power plants.

Company certification according to the following Standards: UNI EN ISO 9001:2008 (since 1983) and UNI EN ISO 14001:2004 (since 2000).

Products:

Electrodynamic voltage regulators Ministab & Sterostab in power range from 1 to 4000kVA.

Luminous flux regulators Stabilux in power range from 3.5 to 220 kVA.

Micro hydroelectric power plants Ecowatt in power range from 500W to 150 kW.



Automatic Voltage Regulators

IREM S.p.A. a socio unico - Via Abegg, 75 - 10050 Borgone (TO) - Italy

Tel. +39 011 9648211 - Fax +39 011 9648222

irem@irem.it - svm@irem.it - www.irem.it

Contact - Sandra Busso, Renato Longo



ITALWEBER S.p.A., Italian producer of high quality components for electrical protection since 1960. Our production is focused on: Fuses and Fuse Holders for Low Voltage, Medium Voltage and Photovoltaic applications, according to European, British and US standards, Cabinets and components for Photovoltaic plants, Motor Protectors, Insulators, Cable Glands, Flexible Copper Bars, Thermoplastic Enclosures, Low Voltage Transformers with approvals, Surge protective devices, Cam Switches and Control Switches.

Products:

Fuses and Fuse Holders, Low Voltage Transformers, Cams Switches and Control Switches, Protection components for photovoltaic application.





conducting here!

Visit us at

Stand 3B21

pag. 46



Since 1965, **La Triveneta Cavi** has been one of the major players within the European market for low and medium-voltage cables up to 33 KV (PVC, Neoprene) for various sectors: industry, residential, power distribution, renewable technologies. All cables are VDE, LCIE, IMQ, UL, CSA, BS approved.



LA TRIVENETA CAVI S.p.A. - Via Orna, 35 - 36040 Brendola (VI) - Italy

Tel. +39 0444 705200 - Fax +39 0444 401244

info@latrivenetacavi.com - nicola.zini@comfra.com - www.latrivenetacavi.com

Contact - Nicola Zini

Established in 1960, **Lanzini Illuminazione** prides itself on more than 50 years of experience in the lighting sector. The products are “Made in Italy” and they meet the customers requirements for industrial, residential, architectural, urban, road and emergency use. Lanzini Illuminazione exports all over the world and it is certified UNI-EN-ISO9001:2008 (vision 2000).

Products:

Kono Up Led, Triled, Poliled, Pilot, Faro, Bobsled, Spider, Asiled.



LAYER ELECTRONICS is an Italian leading company producing Industrial U.P.S. up to 1600 kVA, A.V.R. (Stabilizers) up to 2000 kVA, DC/AC Static and Grid Connected Inverters, Wind Generators up to 20 kW, On-grid and Off-grid Solar and Wind Power Plants, Charge Regulators, Cathodic Protection Power Supplies, Frequency Converters and anything else, which you may require from us. Since 1967 Quality and Reliability are our key-words. We are looking for dealers/distributors of our products. Made in Italy: All LAYER products are designed, manufactured and tested in Trapani - Sicily.

Products:

Industrial U.P.S., A.V.R. (Stabilizers), Solar and Wind Energy.



Hybrid solar/wind off-grid power plant 90 kW installed in Kashobwe, D.R. Congo



Electronic voltage stabilizer 630 kVA



LEVER

Visit us at
Stand S1G18

pag. 49

UPS tower for IT technology



UPS system composed with two rectifiers 125Vdc
1200 A and two inverter 220Vac 1Ph output,
central change over systems

LEVER S.r.l. power solutions for Oil&Gas and Power Plant. Lever specialized in design and manufacture of uninterruptible power supply systems (UPS), rectifier battery chargers, Inverter DC/AC. The company also provides test laboratory services to its clients. It has manufacturing facilities in Italy. The company was founded in 1973 and is headquartered in Verona, Italy.

Specialties

Heavy duty industrial UPS for Oil&Gas plants, Power solutions for Power Plants

Industry: Electrical/Electronic Manufacturing

Type: Privately Held

Company Size: 11-50 employees

Founded: 1973

Products:

Uninterruptible Power Supply (UPS) from 1KVA up to 500KVA commercial and Industrial systems. Rectifiers battery chargers 110Vdc, 220Vdc up to 2000A, Inverter DC/AC up to 160KVA 1Ph output.

LEVER S.r.l. - Via del Lavoro, 17 - Arbizzano (VR) - Italy

Tel. +39 045 6020202 - Fax +39 045 6020147

info@lever.it - www.lever.it

Contact - Gregorio Giuliani, Dario Campigotto

LOVATO ELECTRIC S.p.A. for 90 years, Lovato Electric has grown and developed in the market of electromechanical and electronic components for electrical equipment which: motor protection circuit breakers, Contact ors, push bottons, soft-starters, protection and level relays, digital multimeters and power analyzers, energy meters, power factor regulators, battery charger and gen-set controllers.





Marlanvil

Living with More

Visit us at
Stand 3C28

pag. 51

Marlanvil was founded in 1985 in Italy. We design and manufacture a wide range of electrical installation and lighting solutions for domestic, tertiary and industrial use, including: Modular switches&sockets, watertight boxes, Flush&wall-mounted distribution boards, bulkheads, Enclosures, derivation boxes, Wiring accessories, Industrial plugs&sockets, Industrial and indoor floodlights. Please come visit us!

Products:

Wiring accessories as cable ties, cable pullers, blanks boards, etc, Industrial plugs and sockets, Material IEC309 and distribution boards, Industrial floodlight, Highbay, Tunnel lights, PL downlighter lamps for indoor appliances, Bulkheads for indoor and outdoor.



MARLANVIL S.p.A. - Via Campania, 11 - 24040 Ciserano (Bg) - Italy
Tel. +39 035 4186850 - Fax +39 035 885208
info.export@marlanvil.it - www.marlanvil.it
Contact - Daniela Daluiso, Luigi Benelli



Milantractor was established in 1971 in Milan, Italy. Since then has developed its activity, extending it to all kinds of industrial applications for Diesel & Gas engines and related after-sale services. Over the years, the operational structures of the business have been adjusted to its growth. Thanks to the experience and the technologies the company has acquired over the years, it now has a reference role in every sector in which it is active. The constant attention we pay to Customer Satisfaction, by strict application of UNI EN ISO 9001 standards, means that great care is taken with regard to project and service needs.

Products:

Energy Solutions (according to construction specifications: Atex, NFPA20, etc.): Generating Sets, Engine Driven Process Pumps, Fire Fighting Systems, Cogeneration.

Energy Rental: Generating Sets (also Medium Voltage), Tower Lights, Containerized Substations, Load Banks, Containerized Inverter.

After Sales Services, FG Wilson Dealer, VM Motori, Lombardini, Kholer Dealer.



Atex Mobile Process Pump
(Caterpillar Engine)



1500 kVA Medium Voltage Genset
(Under Construction)



Keys Distribution Exchange Box



Bolt Locks

New Arel S.r.l. has been active for more than forty years in the production of camlocks and interlocking systems. The company works with professionalism in order to guarantee systems capable of preventing accidents caused by human error. For this purpose, provides professional advice for the design of personalised devices. The quality of systems produced by New Arel has made them a partner of trust to numerous renowned companies in the energy and railway sector.

Products:

Interlocking Devices (Bolt Lock – Exchange Boxes – Door Locks), Camlocks & Handles.

NSM is operating since 1963 in the manufacturing of synchronous alternators, welder, DC generators, Permanent Magnet Generators, PTO generators, frequency converters and special 400HZ machines. NSM in part of "The Energy Network" that includes the following companies: Amer S.p.A., Italsea S.r.l., Sir S.r.l., Schumo AG, Amer Electric Motion USA and Antamatic S.r.l.

Products:

Synchronous alternators, AC and DC welders, DC generators, Generators for special applications.





Orefice Gruppi Elettrogeni was founded in 1938 and produces generating sets from 3 up to 3000kVA. The Orefice generators are designed for many applications, with special attention to the professional and heavy duty applications. Orefice Gruppi Elettrogeni complies with CE regulations and 2000/14. The quality is certificate ISO9001. Over the standard products, Orefice can design generators by customer specifics. Our production system allows us to realise a quality product and in the meantime to place great importance on the quality of the work environment.

Products:

Gasoline, Diesel, Gas and Syngas Generators, Lighting Towers, Engine Driven Welders.



ORTEA S.p.A., founded in 1969, is now a leading manufacturer of Digital Voltage Stabilisers and magnetic components (transformers, chokes and reactors). In addition to standard products, ORTEA is organized to be extremely flexible in designing and producing according to Customer's specifications. The belief that Customer satisfaction, product quality, environmental care and attention to safety issues are the basis for a modern organization has led to the development of an ISO9001:2008, ISO14001:2004 and OHSAS18001:2007 approved Integrated Managing System.

Products:

Voltage stabilisers, voltage transformers, chokes and reactors.





Perin Generators Group is an important organized company, highly estimated all over the world for its important references.

350 generators are available for customers to be hired and our sale product is more than 1000 generators per year covering many fields all over the world.

Products:

Alternators, Cogeneration, Generators, Engines, Power Plants, Turbines.

PERIN GENERATORS GROUP - Via Guido Rossa, 7 - 31030 Colfosco di Susegana (TV) - Italy

Tel. +39 0438 27074 - Fax +39 0438 758823

commit@perin.com - comm.davide@perin.com - www.perin.com

Contact - Davide Perin

Pizzato Elettrica was established in the year 1984 at Marostica (Vicenza), Italy, and is now one of the most important European companies manufacturing position switches, microswitches, foot switches, control and signalling devices, safety switches and safety modules. A dynamic company focused to the market development, since its beginning has experienced a constant growth, achieving a leading position in the Italian and European markets. Since all the products are designed and assembled inside, the company is able to satisfy any time the specific requirements of the customers offering a range of 7000 standard articles and more of 1000 special items.

Products:

Position switches, microswitches,
Foot switches, control and
signalling devices, Safety
devices, safety modules.





QUADRITALIA is one of the European leaders in the field of manufacturing of enclosures for the industrial automation and distribution, with a range of products that goes from the wall mount boxes to the complete modular floor standing enclosures, from the consoles to enclosures' accessories, and the customized products.

An efficient and motivated staff, together with our wide domestic and international commercial network, assure a complete support to all customers, enriched by the flexibility and efficiency of our Technical Department, ready to satisfy any requirement. The great expertise, achieved through more than 25 years of activity, and the knowledge and presence on many international markets makes Quadritalia not only a simple supplier of our customers, but rather a strategic partner.



Products:

Floor standing enclosures, wall mount boxes, modular and monoblock consoles.





RODA CAVI was founded in 1985 with specific objective of manufacturing special and custom cables. All the cables we produce are certified for CE-IMQ EU and WRAS UK standards. Strategic position of RODA CAVI in center of Mediterranean Sea makes easy fast delivery service for the Mediterranean and all the world countries. The factory is based in the biggest industrial aerea of Catania (Italy). RODA CAVI is both certified as ISO 9001:2008 for 20 years and able to produce on specific request.

Products:

- | | |
|---------------|--|
| N07V-K | Single core general purpose flexible cables |
| FG7(O)-R | Power cables for fixed installation |
| FG7OM1 | Power cables for fixed installation |
| CLEARWATER | Cables for submersible pumps |
| U1000-R2V | Rigid cables for fixed installation with XLPE insulation |
| FROR 450/750V | Power cables for mobile service |
| H05VV-F | Flexible multi-core signaling cables |
| FFROR | Extra-flexible cable for mobile applications |
| H01N2-D | Welding cables |
| H07V-U | Rigid cables with PVC insulation |
| A05VV-U | Rigid cables for fixed installation |



Industrial Socket



Industrial Plug

With growing passion and efficiency, **ROSI** has been producing electrical material for more than 35 years. The Made-in-Italy manufacturing and design make ROSI's product a high-quality one. The whole range of products is the outcome of an extremely scrupulous technical control, from the very first conception of an idea to the final packaging of the product. Thanks to its innovative aptitude, ROSI is growing in structures and aims and is able to meet the specific, ever-changing market demands.

Products:

Industrial plugs and sockets, Multipliers and adaptors, Interlocked sockets, Motor protections, Safety switches, Industrial cable reels and extension cables, ASC panels for building sites (portable panels, compact panels, etc.), Industrial panels, ASD panels, ASC panels in butyl rubber, Industrial wall enclosures, Accessories.

ROSI Electrical Products

Via Marabotto, 180 - 29010 Castelnuovo Fogliani, (PC) - Italy
Tel. +39 0523 947166 - Fax +39 0523 947480
info@rosi-it.com - www.rosi-it.com

SAER ELETTROPOMPE S.p.A. offers innovative solutions in the water field, with a complete range of surface and submersible motors (up to 400 HP) and pumps (up to 5000 m³/h) entirely Made in Italy, for applications in civil, industrial, marine, mining, municipal, Oil & Gas, R.O., agriculture, irrigation, fire-fighting etc. Flexibility, R&D, know-how, full automation of the processes and collaboration of highly qualified staff are the key elements of SAER success.

Products:

Split casing pumps, High Pressure pumps, Ballast Pumps, End-suction, Close-Coupled, Stub-shaft pumps, Horizontal & Vertical multistage pumps, Submersible pumps & Motors, Residential Pumps, Booster sets.



SKD Split casing pump completely made in Italy,
flow up to 5000 m³/h, materials: bronze, s.s., c.i.



TM High pressure pump, up to 63 bars, available in
s.s.316, c.i., DUPLEX. Also vertical version.



Smart grid solutions



Automation and communication for utilities

SELTA offers a wide range of customized communication and automation solutions for advanced Utilities networks and SMART GRIDS.

SELTA operates internationally, creating flexible and efficient solutions for the transmission and distribution of electricity, power, water and gas.

System architectures designed by SELTA are compliant with the main international standards, thus keeping a full fitting with the already existing networks. This key strength ensures continuity and maximum reliability for the user's services.

Products:

Remote control and monitoring solutions for Utilities networks and SMART GRIDS, Local automation of electric substations, Private telecommunications networks, power line carrier systems.

SELTA S.p.A. - Via Emilia, 231 - 29010 Cadeo (PC) - Italy

Tel. +39 0523 50161 - Fax +39 0523 5016333

info@selta.it - www.selta.com

Contact - Andrea Bricchi



SICES S.r.l. is the Italian company leader in the field of design, production and start-up of **LV ELECTRIC CONTROL PANELS** and **ELECTRONIC DEVICES** for **GENERATOR SETS** equipped with diesel, gas or vegetable oil engines. In detail SICES S.r.l. can offer:

➤ **ELECTRONIC DEVICES:** AMF, SPM and SYNCHRO/PARALLEL controllers, which can be combined with several devices for monitoring and expanding the functions of the controllers.

➤ **COMPLETE CONTROL PANELS:** SICES S.r.l. offers the engineering support and the technical skills to provide top quality control panels for standard and customized needs.

Products:

GENSET CONTROLLERS:

Discover the new models of controllers **GC315**, **GC310** and **GC350**, SPM, AMF and ATS controllers for single stand-by gensets.

Don't miss **GC500Plus** and **DST4602** genset controllers, the controllers for Synchro/Parallel applications.

LV CONTROL PANELS FOR GENSETS:

Comprehensive panels for different applications SPM, AMF, ATS and Synchro/Parallel (CHP plants included)

REMOTE MONITORING SYSTEMS.



SICES genset controllers



Since 1987 **Sincro** designs and manufactures 2 & 4 poles synchronous alternators, low and medium voltage up to 2,6 MVA, AC/DC rotating welders from 130 to 500A, DC generators for Telekom and L.E.D. lighting towers, PMG for wind turbines and special executions for Marine, Oil & Gas and Military applications.

Products:

Synchronous alternators, AC & DC welders, Generators for special applications.

Spark Energy S.r.l. designs, constructs and operates DISTRIBUTED POWER GENERATION PLANTS based on endothermic motors using otto and diesel cycles.

Its wide product range allow the realisation of power plants fuelled by fossil or renewable sources and can produce electricity, heat and cooling in generative, cogenerative and trigenerative configuration.

Technical expertise, production control and process added to EMS Division, that keeps efficiency of the system, make the difference on operating hours.

Products:

Diesel Generating set, CHP (Combinated Heat and Power) units, CCHP (combinated, heat, power and cooling) units.



Energy Efficiency:
Bluespark Natural Gas Power Plant



Power Generation:
Oil and Gas Power Plant



Since 1972 we have been designing and manufacturing, entirely in Italy, caps, level gauges and loading systems for sound proof canopies, fuel, lubricants and auxiliary liquids tanks. Main sectors: generating sets, agricultural and industrial machines, oil-hydraulic equipment, motorcycles, ultralight aircrafts, boats, trains, etc. The experience acquired and the continuous research of technical innovations in order to find the best solution for our customers, have made us a leader in our field, as well as quality and reliability of our products at competitive prices.

Products:

Fillers, caps, mechanical visual level indicators, niches and complete loading systems.

Teaflex S.p.A.: on the market from 70's, is a leader company for INDUSTRIAL CABLE PROTECTION and has been manufacturing in Italy metal and plastic conduits, together with fittings, cable glands, pipes, braids. In addition to standard objects, Teaflex designs and produces customized items according to customer specifications. From our website you can download PDF data sheets concerning all our items, 3D CAD models, our catalogues. Teaflex items are characterized by exceptional versatility, that allows its use in different sectors: civil and industrial plants, robotics, electric and nuclear power stations, machine tools, railways, highways (tunnel too), food industry, shipbuilding industry, signaling. The company is certified by the most important Italian, European, Worldwide institutions, as detailed in our website.

Products:

Metal and plastic conduits, Metal and plastic fittings, Accessories, boxes, cable glands, braids, News: EX line, EMC line, Stainless steel line.



Teaflex EX catalogue



Teaflex EMC catalogue



TEKNOMEGA, was incorporated in 2004 and after a few years it stands out as a market leader in components in its three market fields: PANELBOARDS DIVISION (components for Low Voltage Panel boards), FIXING DIVISION (versatile systems for Fixing and Supporting of industrial installation) and PHOTOVOLTAIC FIXING DIVISION (structures for the solar PV energy sector). Electrical products of TEKNOMEGA Panel Board Division are a wide range of high quality Electrical Materials to carry, isolate and distribute electric current in low voltage panel boards. TEKNOMEGA also comes out with credential of specialistic competence in the Fastening Solutions market thanks to innovative and certified products. Moreover, TEKNOMEGA studied a range of products for the Photovoltaic and Solar Energy sector to fix every installation component to the structure. These products are the best choice for many applications, from the flat roof to the inclined pitched roof. TEKNOMEGA experience in the Fastening Solutions sector brought to the creation of Ω Solar, a brand new set of Mounting Components for Photovoltaic and Solar Panels.

Products:

Insulated Copper Flexible Bars and Accessories, Universal Bar Supports Ω TOP and low voltage insulator, Distribution Blocks and Brass Terminal Bars, Spring Steel Fasteners Ω CLIP, Clamps and Collars Ω CLAMP, Strut Channels Ω STRUT and Cantilever Arms, Fixing Structures for Photovoltaic Panels.

Thytronic S.p.A., is a company specialized in developing and manufacturing Protection & Control solutions needed for electrical power generation and distribution. We provide single and multifunction digital protective relays suitable for wide range of application, from the generation to the distribution of electric power. Thytronic protective relays are designed for the selective protection of generators, overhead and cable feeders, capacitor banks & harmonic filters, motors, transformers and busbars in power system distribution, substations, power plants, industrial power system and offshore installation. Indoor Earth Fault Indicators (EFI) for secondary distribution system complete our offer. Competitive products, customized service, rapid delivery and the attentive evaluation of the customer needs have all contributed in making us one of the best and reliable independent manufacturer of protection relays.

Products:

Protection relay.





VEMER S.p.A., located in North Italy Vemer is an industrial manufacturer of more than 1000 items to meet the requirements of modern installers for civil and industrial use. Over 30 years of experience makes Vemer Leader in Italy and successful in more than 40 international markets.

Climate control, time management, gas-safety, measurement/control, heat regulation, insulators and busbar support is its wide offer to measure and manage the major electrical parameters.

Thanks to UNI EN ISO 9001:2001 Quality Certification System Vemer assures the quality of its products and the efficiency of its staff.

Products:

Chronos Black touch screen programmable thermostat, Simply-D Daily time switch, Ht Nipt-1P3D Heat regulator.

VEMER S.p.A. - Via Camp Lonc, 16 - 32032 Villapaiera Feltre (BL) - Italy

Tel. +39 0439 879892 - Fax +39 0439 879877

marketing@vemer.it - www.vemer.it

Contact - Antonio Peron



Work Italia is active since 86 in production and sale of quality products in safety against electrical risks industry. Integrity, commitment and ability to anticipate the market needs have led to what Work Italia is today: a highly specialized organization. This continuous research of specialization have enabled our company to occupy a leading position in Italy and abroad becoming one of the most important supplier of producers, distributors and users of electric power with its certified products.

Products:

Short circuiting and grounding equipment for LV-MV-HV overhead lines, Short circuiting and grounding equipment for LV-MV-HV electric cabins and installations, Equipotential and continuity equipment, Insulating rods for grounding equipment, switches disconnection, MT fuses extraction and special applications, LV-MV-HV voltage detectors, Insulating rubber carpet, Insulating blanket, Insulating board, Dielectric gloves.



WI RTRF/EA0271 - Device for voltage detection and phase correlation for MV lines and substations



WI 560/A - Short circuiting and grounding equipment for HV overhead transmission lines

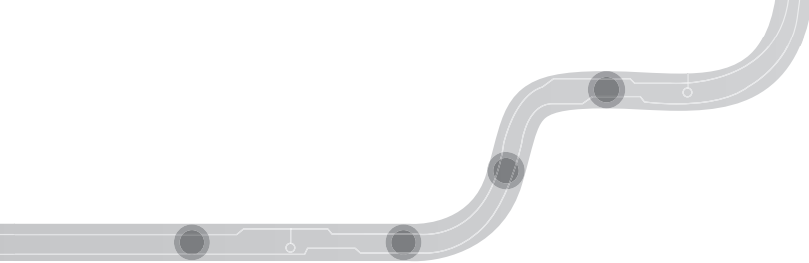

ITALIAN TRADE AGENCY
ICE - Italian Trade Commission
Trade Promotion Office of the Italian Embassy



**FEDERAZIONE NAZIONALE
IMPRESE ELETTROTECNICHE
ED ELETTRONICHE**



CONFINDUSTRIA



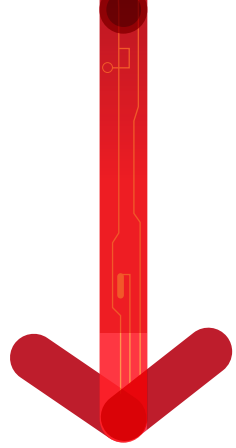

ITALIAN TRADE AGENCY
ICE - Italian Trade Commission
Trade Promotion Office of the Italian Embassy



FEDERAZIONE NAZIONALE
IMPRESE ELETTROTECNICHE
ED ELETTRONICHE



CONFINDUSTRIA

