



**L'efficienza energetica e l'integrazione
degli elettrodomestici**

Presenter: Paolo Faraldi

ANIE

Milan – December, 18th 2009

Our Company

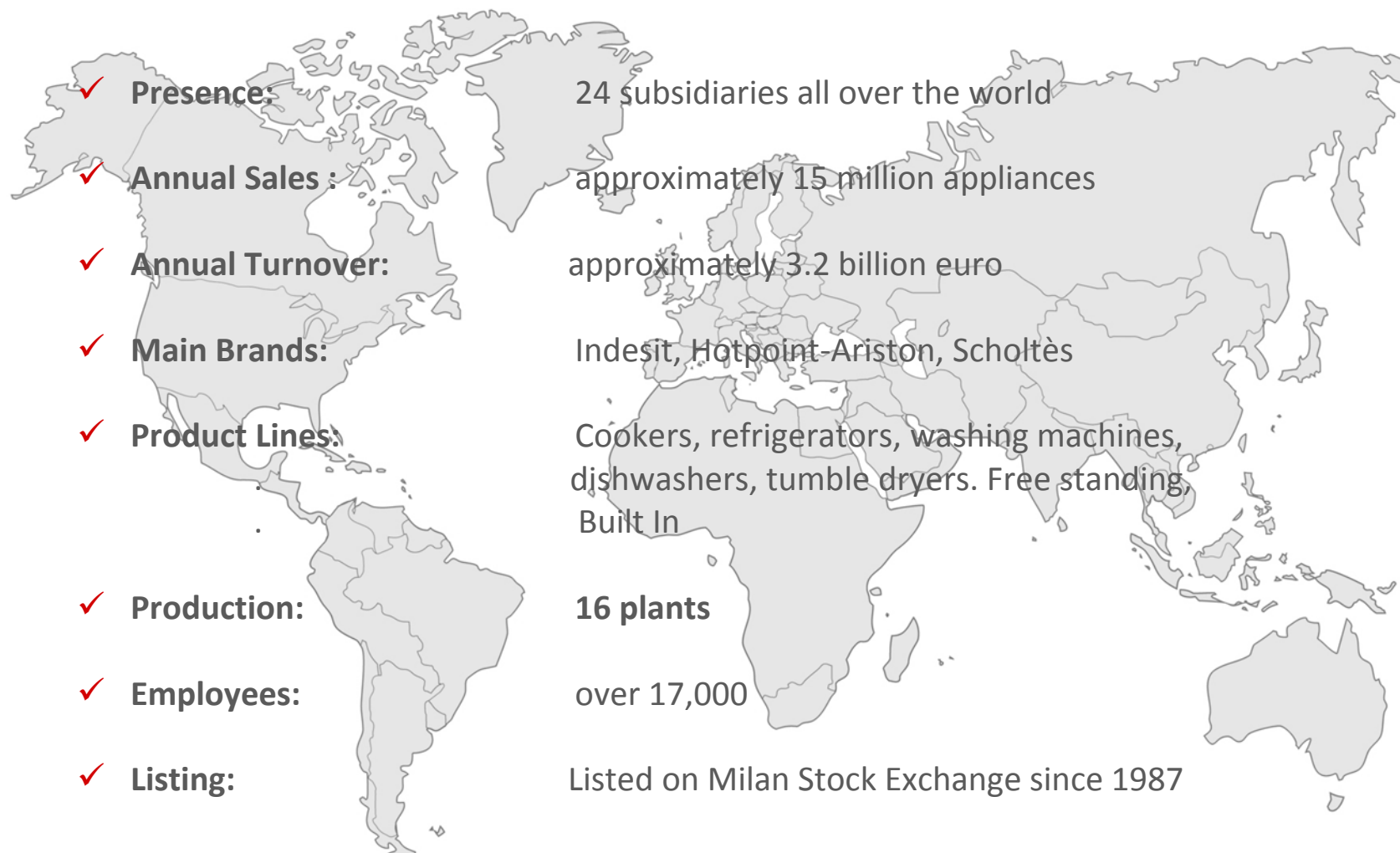

Indesit Company: Milestones

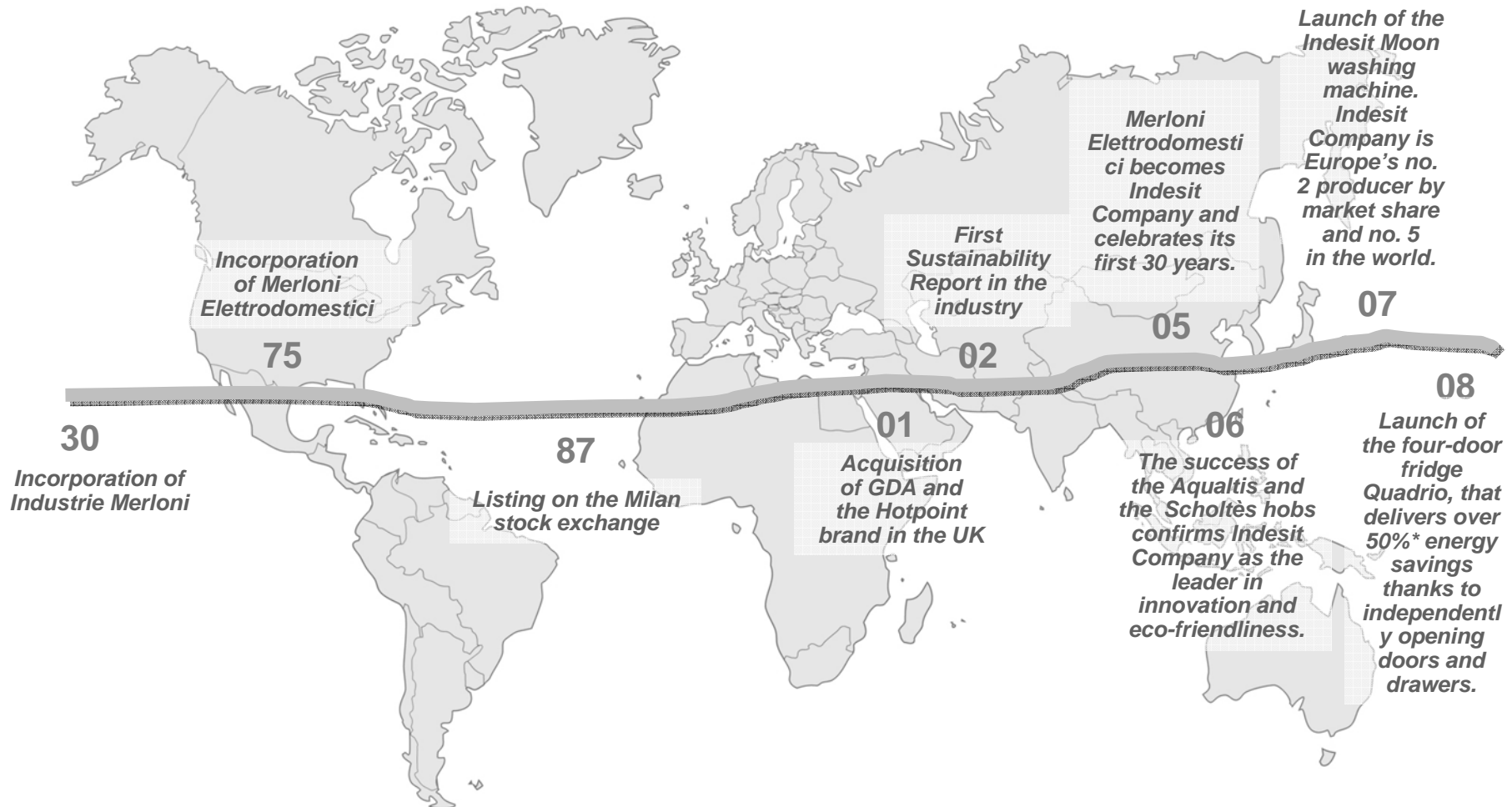

Our History

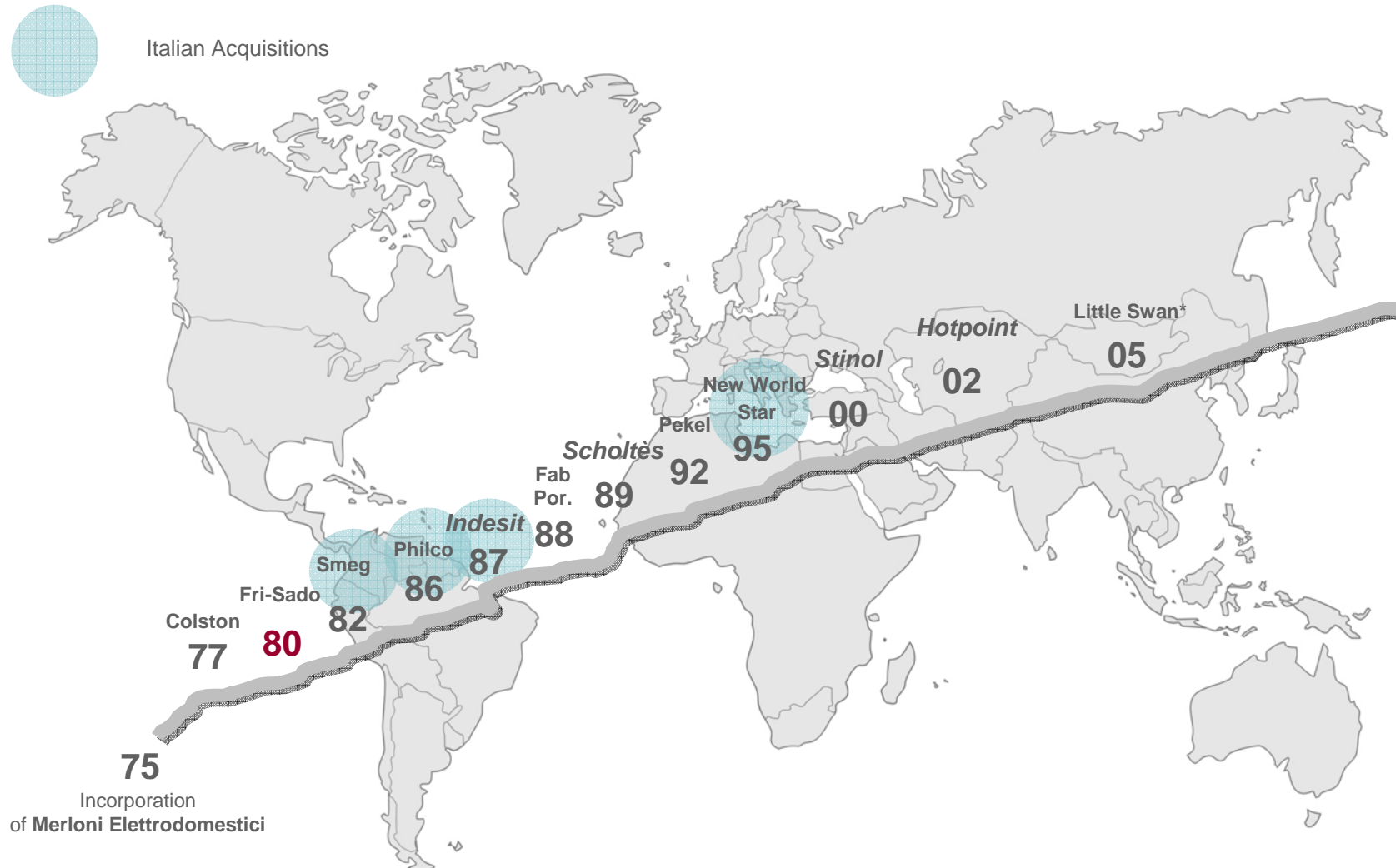

Indesit Company: Our Values

Philosophy

“There is no value in the economic success of any industrial initiative if it is not also accompanied by commitment to social progress.”

(Aristide Merloni, 1967)

Mission

To be a global leader, producing eco-compatible technological solutions that give people “quality time” everyday.

Values

Indesit Company is determined to improve in everything it does. This ambition is expressed in its five values, which also represent its style: *innovative, respectful, ambitious, in touch with people and genuine.*

Our Presence: Industrial Footprint

✓ **16 Factories in Europe**

- *UK:* Dryers
- *Italy:* Dishwashing, Cooling, Washing, Built-in Cooking
- *Poland:* Cooling, Cookers; Washing, Dishwashing
- *Turkey:* Cooling
- *Russia:* Cooling, Washing



Our Presence: Commercial Offices

✓ 25 Subsidiaries all over the world

✓ **Extra-EU:**

- *Singapore*
- *Shanghai*
- *Dubai*
- *Buenos Aires*





We work, you play

The Group's pan-European brand, Indesit, was acquired in 1987. With its characteristics of technological innovation and ease of use, the Indesit brand addresses a target of young and dynamic people who want to live life to the full. A consumer profile that requires products with a modern design and innovative, intuitive technological solutions that make life simple and free up time. It is to meet these needs that Indesit decided to be a "smart solution for enjoying contemporary life".



 **Hotpoint**

ARISTON

Our ideas, your home.

In 2007, Ariston merged with Hotpoint, a combination featuring the international appeal of Hotpoint, undisputed leader in the UK market, and the style and tradition of Ariston. Hotpoint|Ariston makes washing machines, washer-dryers, dishwashers, fridges, freezers and built-in cookers. Its payoff - "Our ideas, your home" expresses the brand's commitment to offering its consumers solutions stemming from a deep understanding of what they're looking for in their home. And is thus in line with its three brand values: intelligence, comfort and style.



Taste and perfection

The prestige French brand acquired in 1989 and launched in Italy at the end of 2003 is Indesit Company's top of the range built-in brand. Scholtès products embody "recognised professionalism", the essence of the brand. Only Scholtès provides demanding users with truly innovative, perfectly designed machines for cooking, cooling and washing. Their sophisticated style goes hand-in-hand with professional performance. Appliances like these make users proud: of their talent, of the perfect results they get, of their homes and lifestyles. These products are immediately recognized as coming from Scholtès: they are true icons, standard-bearers for uncompromising quality and professionalism.

Innovation & Digital Design at a Glance

- **580** employees working in R&D around Europe
- **150** researchers
- **Indesit open innovation model** is based on a wide-reaching system of networking that involves universities and research centres in Italy and abroad.
- Indesit is thus able to establish collaboration relationships right from the initial phases of concept design and development.



*The “Not Invented Here Syndrome”
is not a threat for us!*



Innovation Model: New School

Fabriano site coordinates offshore labs

DIRECT INVESTMENTS

- ⇒ Politechnic of Turin
- ⇒ Politechnic of Milan
- ⇒ ID² Lab for ICT

Long Term Liaison

- ⇒ Parma University
- ⇒ Marche University
- ⇒ UniMoRe Lab

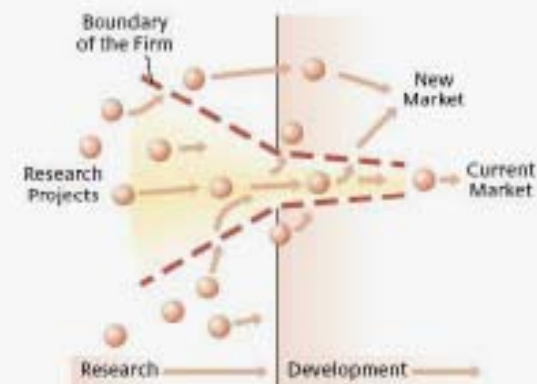
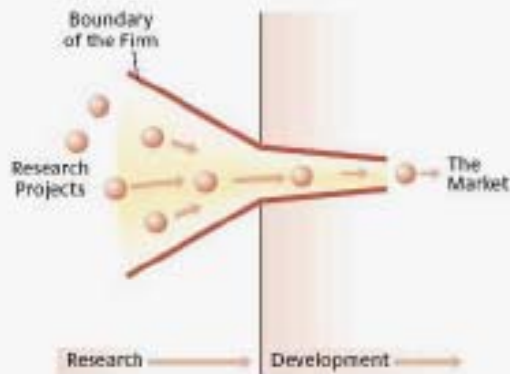

Total Openness to improve the quantity of ideas

Macro Consumer Trends in Appliance Market

SIMPLIFY LIFE



Simplification of purchase, use, interaction and maintenance of the appliance

FLEXIBILITY



Adaptability, flexibility of the appliance to different usage

ENVIRONMENT



Sensibility to the impact of the appliance usage for the environment

PREMIUMNESS



Search for aesthetic impact and premium content in appliance

Indesit and Environment: Ecotech



Eco Tech:

- For Indesit Company, “intelligent” respect for the environment, meaning the capacity to ensure maximum savings of resources, is perfectly in line with the brand values and is becoming an increasingly important demand on the part of consumers.
- To this end, a communication concept known as “Eco Tech” was developed and will involve all the Hotpoint-Ariston products in which “resources saving” is an important asset.

**INDESIT WON THE ECOHITECH
AWARD 2009!**



- The first product to carry the label will be the **Flexipower**, the best-in-class dishwasher in terms of consumption, guaranteeing water and energy savings of 10% with respect to a class A dishwasher.
- This year, the “eco-label” will be extended to the **Quadrio**, the new **Aqualtis** washing machine and washer-dryer range (ensuring water savings of 29% thanks to “care” technology), the **Openspace** oven and the washing machines that use cold cycles, with 50% energy savings compared to traditional wash cycles.

Energy and Appliances

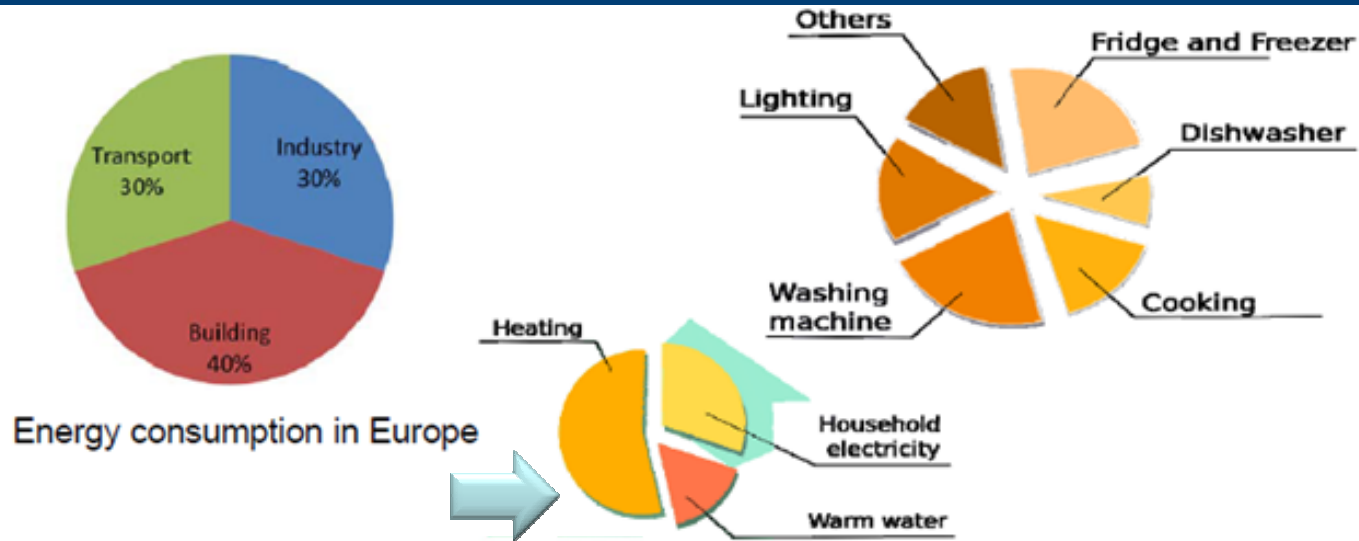

- The 1st step to lower the energy consumption is to monitor it

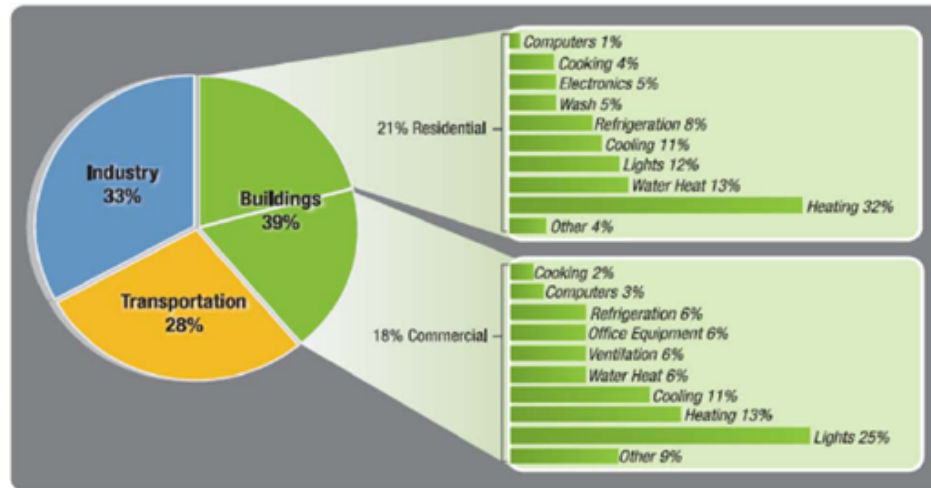

10%
 saving expected
 by active monitoring
 (Source: Oxford University)

Source: Building Energy Data Book, U.S. Department of Energy, Office of Planning, Budget and Analysis, Energy Efficiency and Renewable Energy Prepared by D&R International, Ltd., September 2008

One Example: Spain

The demand peaks are a real challenge!



Load curve

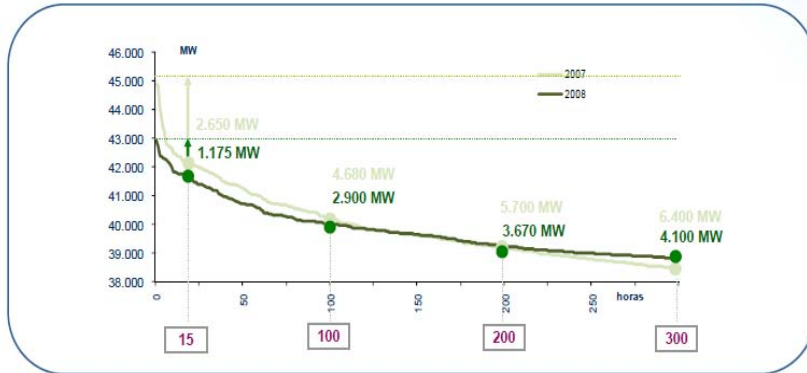

4.100 MW were needed in 2008 only to supply demand during the 300 hours of higher demand during the year

Residential End Uses

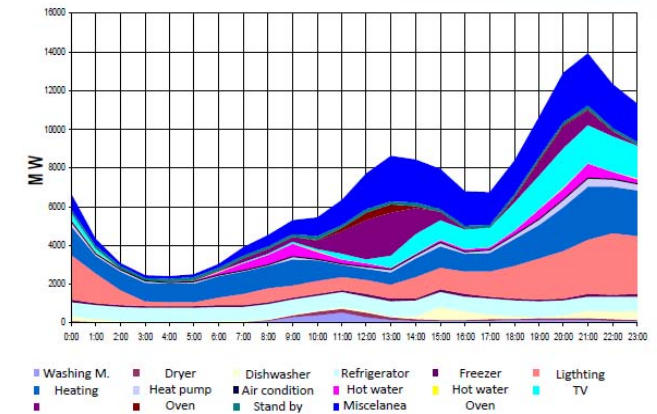

Source: ADER, Residential Demand Analysis project, Red Eléctrica de España, 2008

Example of the impact of selected DSM actions on the Residential Sector

- **Baseline**
 - Average winter day
- **Selected actions.**
 - Movement of 50% of the demand on washing machine and dishwasher from peak to off peak (timer's use).
 - Reduction of 15% of the demand on lighting (CFL).
 - Reduction in the heating demand:
 - 10% in improvements in home insulation and more efficient products
 - Additional 15% by reducing temperature thermostat

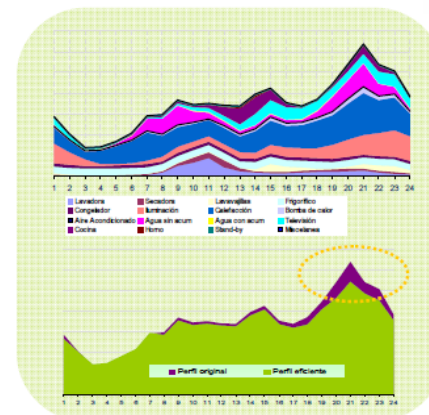

Possibility of reducing the system peak by over 1000MW

From: Suistanible Homes: foreseen trends RED ELETRICE DE ESPAGNA, ICT Nice 2009

Energy BackGround: 20-20-20

The European Policy



- An integrated climate and energy policy is of vital importance:
- Reduction of GHG emissions of 20% by 2020 compared to 1990
- 20% renewable energy sources by 2020 compared to the present 6,5% •
- Saving 20 % of the EU's energy consumption compared to projections for 2020



23/11/2009

6

BeyWatch Consortium Proprietary



POLICY SECTIONS

Energy Efficiency

Energy efficiency: The EU's action plan

Eco-design requirements for energy-using products (EuP)

Funding energy efficiency in the EU

Green buildings

Energy end-use efficiency and energy services

EU Emissions Trading Scheme

Agriculture & Food

Climate Change

Energy Supply

Enlargement

Enterprise & Jobs

Environment

EU Priorities & Opinion

EU Treaty & Institutions

Financial Services

Health & Lifestyle

InfoSociety

Innovation & Creativity

Languages & Culture

Public Affairs

Science & Research

Social Europe

Sports

Sustainable Dev.

Transport & Services

MINI SECTIONS

Central Europe

Competition

Consumers

East & Med relations

Economy & Euro

Education

Elections

Foreign Affairs

Justice & Home Affairs

Security

HOME ► ENERGY EFFICIENCY

News

EU promotes smart metering in fight against global warming

Published: Monday 12 October 2009

The European Commission is calling on member states to support the rollout of technologies to boost energy efficiency, estimating that household energy bills would drop by 10% thanks to smart metering devices. However, no common standards for the devices are currently available.

Brussels adopted on Friday (9 October) a long-awaited set recommendations intended to increase the use of intelligent technologies in the fight against climate change.

At the same time, the EU executive is encouraging the industry to commit to ambitious targets for reducing the carbon emissions of the information and communication technologies (ICT) sector.

Member states are invited to adopt common standards for smart metering systems by 2010 in order to facilitate their deployment across Europe. By the end of 2012, a timeframe should be agreed for the rollout of smart devices in households and offices.

Over time, citizens are expected to reduce their energy use once they are able to easily check their consumption and how much it costs them.

Easy-to-use and pervasive metering devices embedded in specific home electronic equipment - such as televisions, washing machines and computers – or applied to the overall energy consumption of a household are believed to play a crucial role in increasing awareness among citizens and reducing energy consumption, with beneficial effects on climate change.

ICT industry required commitments

The ICT sector is expected to gain considerably from the rollout of intelligent technologies, which will increase the pervasiveness of ICT in citizens' daily lives, boosting revenues among industry players such as IBM or Cisco Systems.

In exchange, the EU executive requires the sector to significantly cut its own energy consumption and CO2 emissions, estimated at 2% of the total. Information Society

BACKGROUND:

In March 2007, EU leaders endorsed the European Commission's proposed '20-20-20' energy and climate change targets (20% renewables in the EU's energy mix and 20% less greenhouse gas emissions by 2020). In December, world leaders will gather in Copenhagen to try to set common goals to reduce CO2 emissions.

In this battle, it is believed that information and communication technologies (ICT) can play a key role. According to estimates by consulting firm McKinsey, widespread use of intelligent devices and applications could reduce global CO2 emissions by as much as 15% by 2020.

In March 2009, the European Commission launched an action plan to increase ICT usage to facilitate the transition to an "energy-efficient, low-carbon economy". The ICT industry was encouraged to cut its own emissions together with helping other sectors to become greener (see EurActiv LinksDossier).

MORE ON THIS TOPIC:

LinksDossier: ICT & climate change: Problem or solution?

News: EU to declare war on business trips

OTHER RELATED NEWS:

- Parliament rubberstamps law on tyre labelling
- Bulgaria to boost energy efficiency, renewables
- EU agrees on new energy-efficiency labels
- EU reaches agreement on energy savings in buildings
- Power firms unveil low-carbon electricity 'choices'

An Example: Swiss

iHome|Lab

HOCHSCHULE
LUZERN

Rates for electricity today

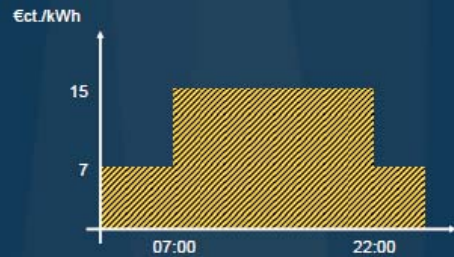

iHome|Lab

HOCHSCHULE
LUZERN

Rates for electricity in 5 years

Rate development forecast

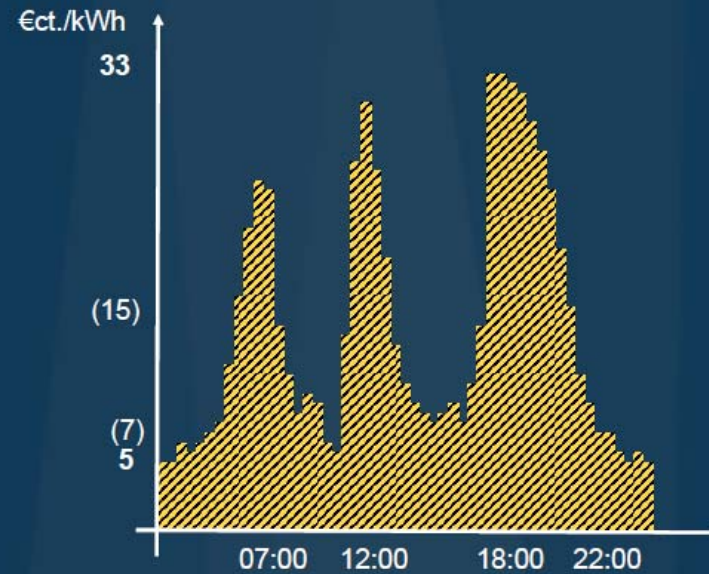

Energy BackGround: Smart Metering in Europe

NES smart meter projects in Europe Installed/Under Contract ~ 30 Mil Smart meters

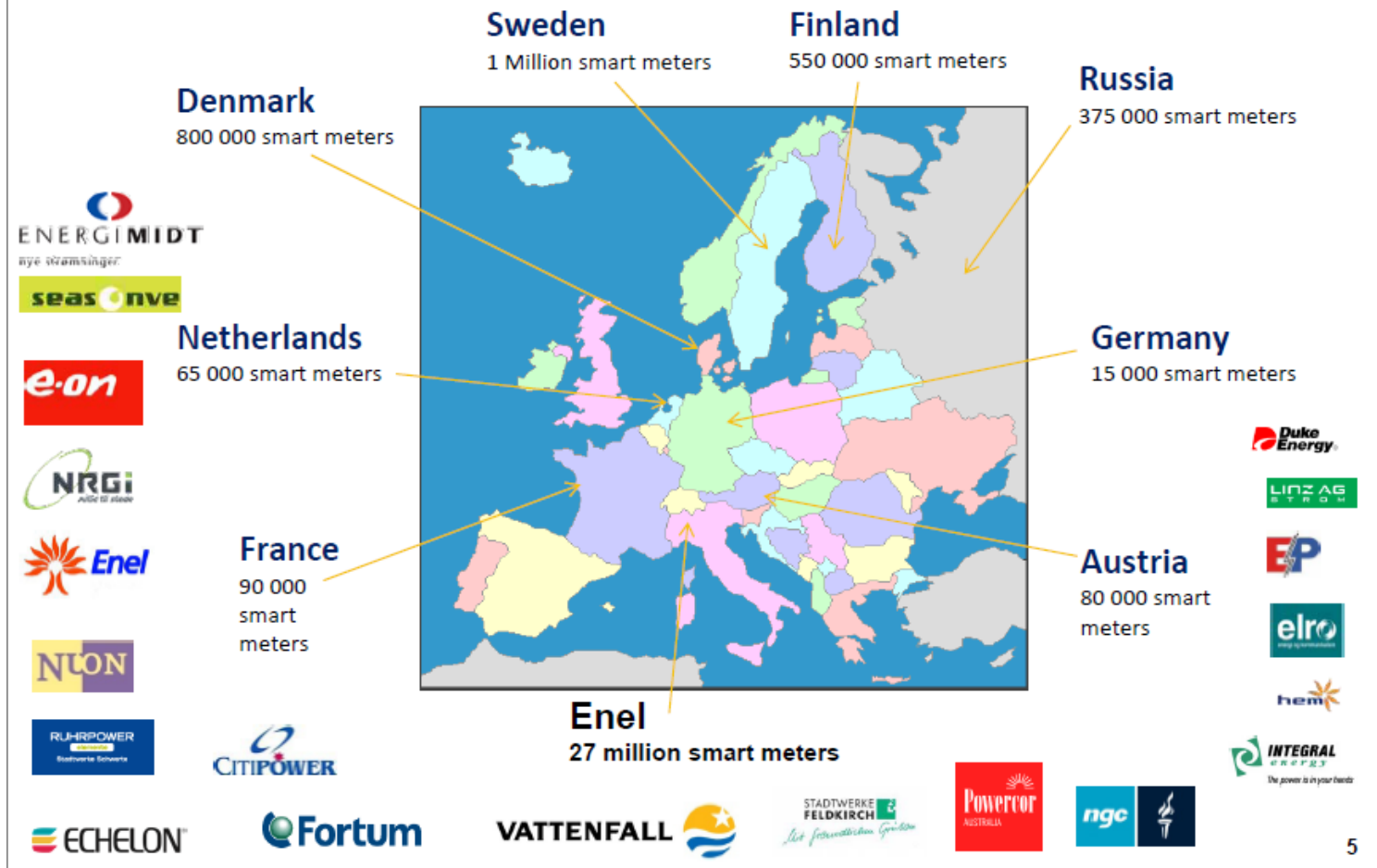

EU Recommendations and Trends

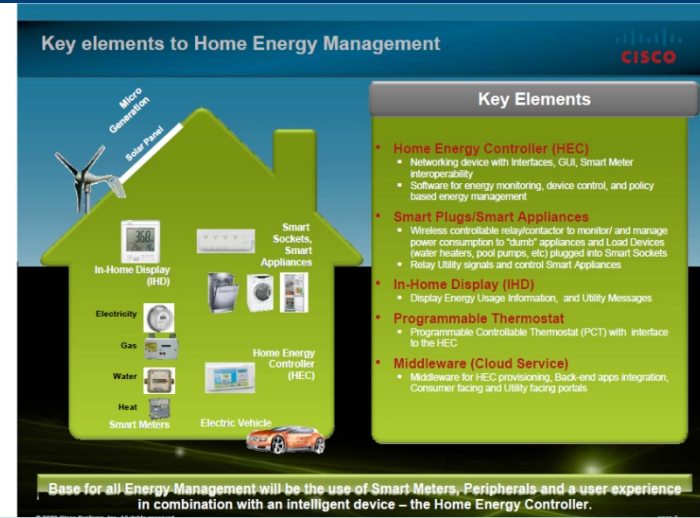
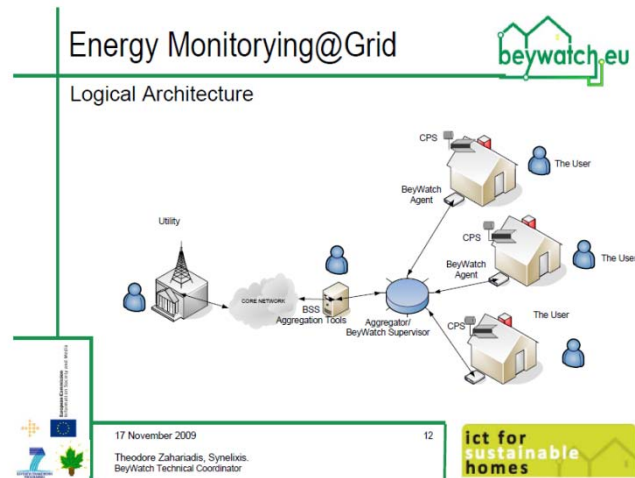

The European Commission issued a recommendation to member states to support the rollout of technologies to boost energy efficiency; it estimates that household energy bills would drop by 10% thanks to smart metering devices. However, no standards for the devices are to date available.

<http://www.euractiv.com/en/energy-efficiency/eu-promotes-smart-metering-fight-global-warming/article-186268>

2. Easier Connection to Home Network with a network adapter (1)

With a network adapter that has network interface, networked appliances will be designed to be independent of communication protocol and media.

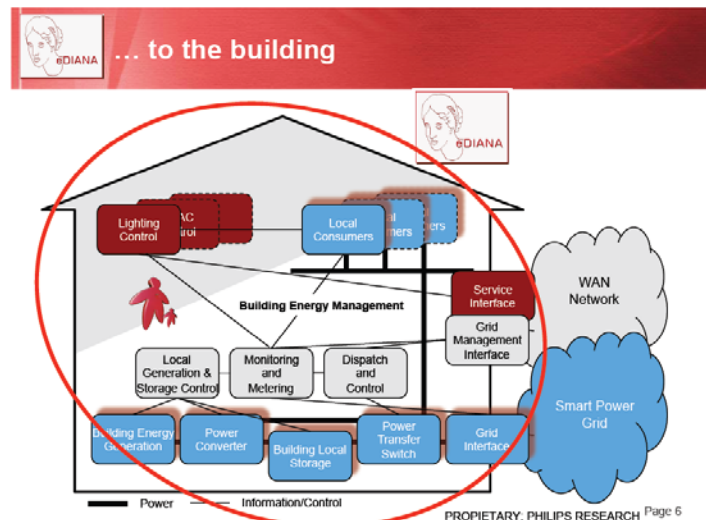
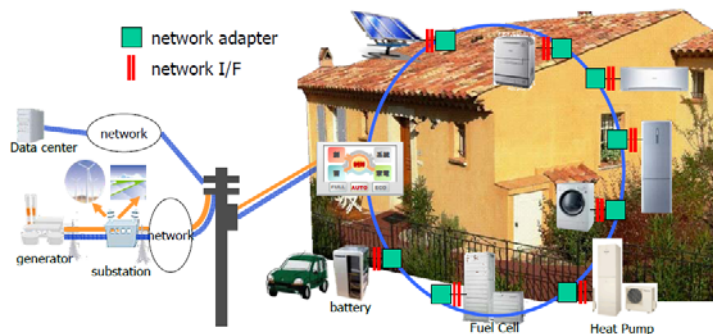

The Future Welcomes You!

Indesit Company is putting a big effort to improve the energy efficiency of our appliances, by:

- reducing the used quantity of water,
- using higher efficiency actuators and motors,
- design low energy cycles,
- bettering their thermodynamics
- designing clever supervisor algorithms and logics

...And we reached outstanding results!

But a brand new possibility is on the edge: Smart Grids and...

Smart Appliances

**A new generation of appliances
to anticipate the future evolution of the home.**

Smart Appliances

- Electric power meter is an important source of information for the appliances, which could automatically dose their use of energy and cooperate to optimize the overall consumption of the house.
- To accomplish all that, Indesit Company cannot be alone; partnerships with Utilities, with Connectivity providers and with Gateways suppliers are a must.
- Also, an interoperable communication standard has to be established.
- Indesit Company is member of the Zigbee Alliance, since we identified it as a very interesting transmission standard.
- Indesit Company is working to implement and extend scopes of ZigBee technology, to enable a full range of new services for our products.



Use Cases

Tele-assistance

Remote Control and Monitor

Appliance Energy Monitoring

Appliance Management Network

Appliance Customization

Data Logging

Preventive Maintenance

Core Technology: Electrical Motor Control

- Electric power for motor actuation and control represents **65%** of the overall Electricity consumption in the Industrial Market [*]
- 290 Billion KWh/Year = **40 Nuclear plant**
- Universal motor or single-phase AC induction motor with simple triac control typically operate at a low efficiency range,
- Brushless DC or 3-phase AC motors, with more advanced electronic control, can achieve an higher operating efficiency.



Energy efficiency via Advanced Motor Control : Dishwasher

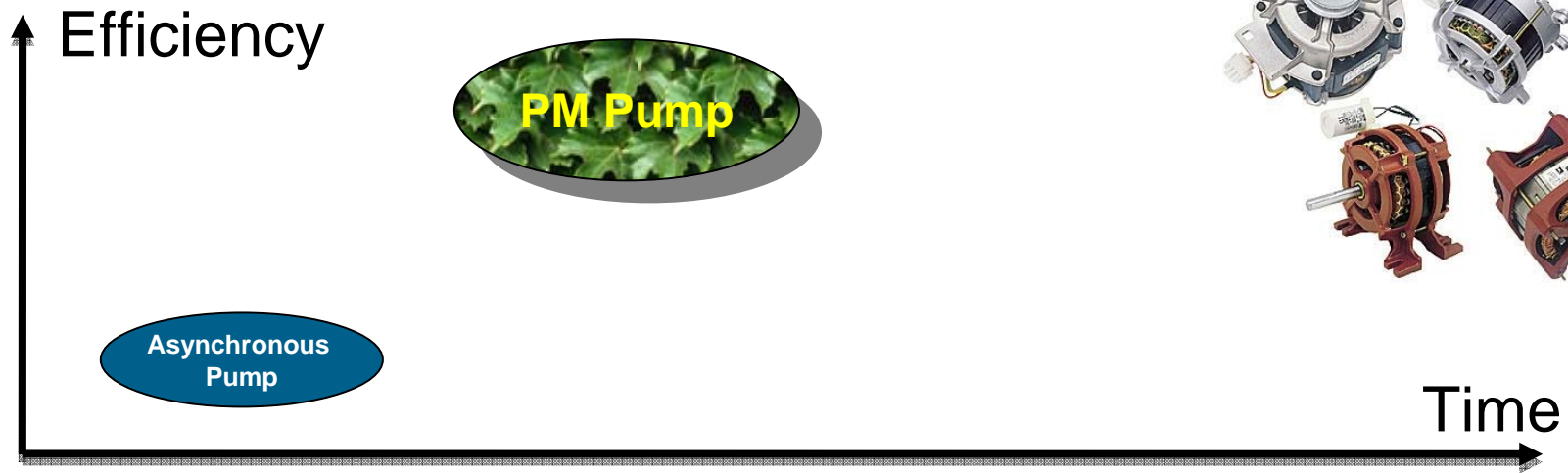

Motor	Typical Power Consumption	Noise
Asynchronous	~150 W	~55 dB
3ph PMSM	~40 W	~43 dB

Energy efficiency via Advanced Motor Control : Washing Machine

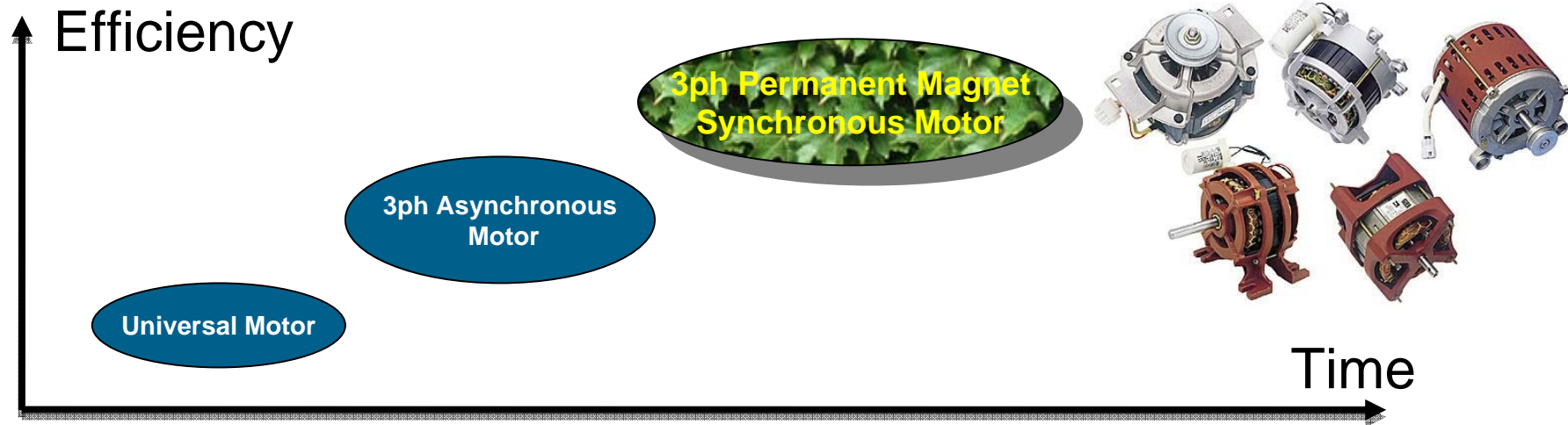

Motor	Efficiency (Washing Phase)
1ph ACIM	20%
3ph ACIM	40%
3ph PMSM	Up to 80%

Appliances : Electronics as Leverage For Flexibility/Efficiency

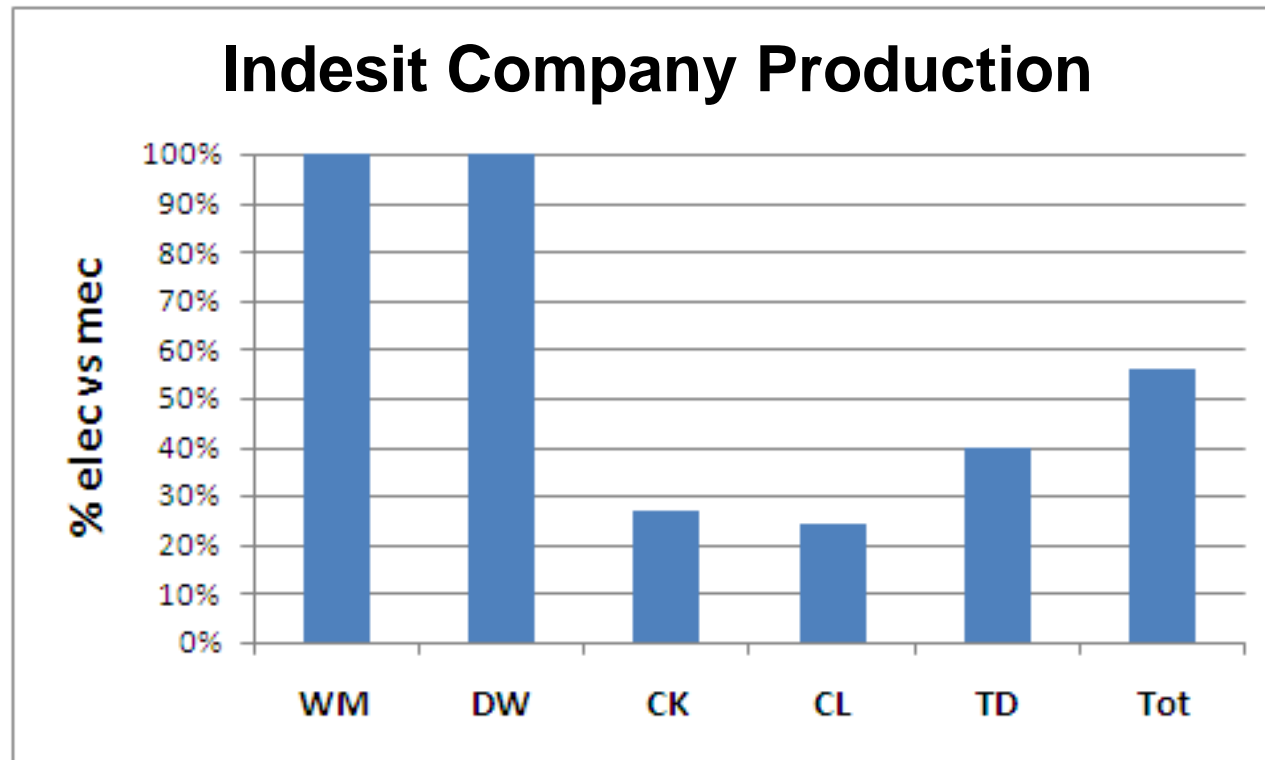

- Indesit Company has a single and whole electronic platform (same devices, same software, same connection system) enabling:
 - maintaining appliances by a PC
 - ready to connect appliances to the Web

Smart Appliances Projects: Energy@Home

Indesit signed an agreement with Electrolux, Enel and Telecom Italia to test an innovative system in which smart appliances optimize home energy consumption.

- The purpose of the "Energy@Home" initiative is to develop a system in which smart appliances will be able to manage themselves by adjusting power consumption of the entire house, thereby avoiding consumption peaks and overloads.
- The project is a further step towards the development of the so-called "smart grids", which, in the future, will allow the transfer of information to appliances that will be able to "self-programme" depending on power supply and prices.
- By doing so, appliances will start functioning at non-peak (and therefore less expensive) times of day, avoiding meter shutdowns due to overloads and automatically balancing consumption without jeopardising the proper execution of cycles.

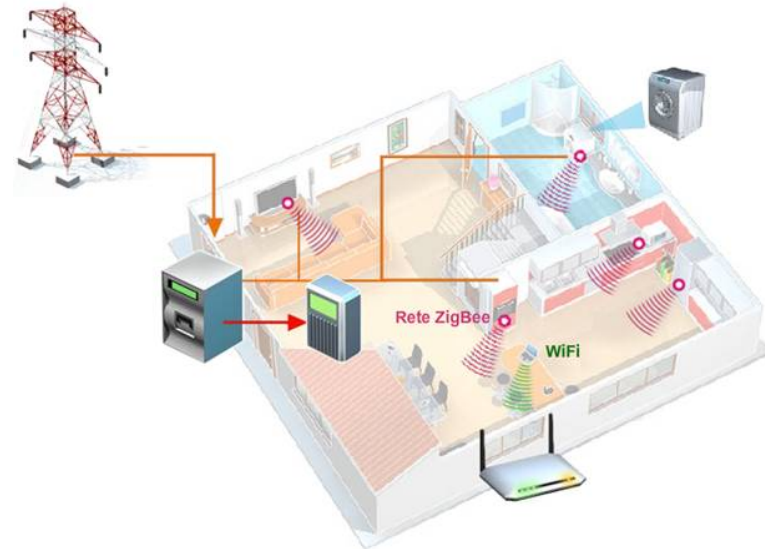

Energy@Home : Technical Architecture

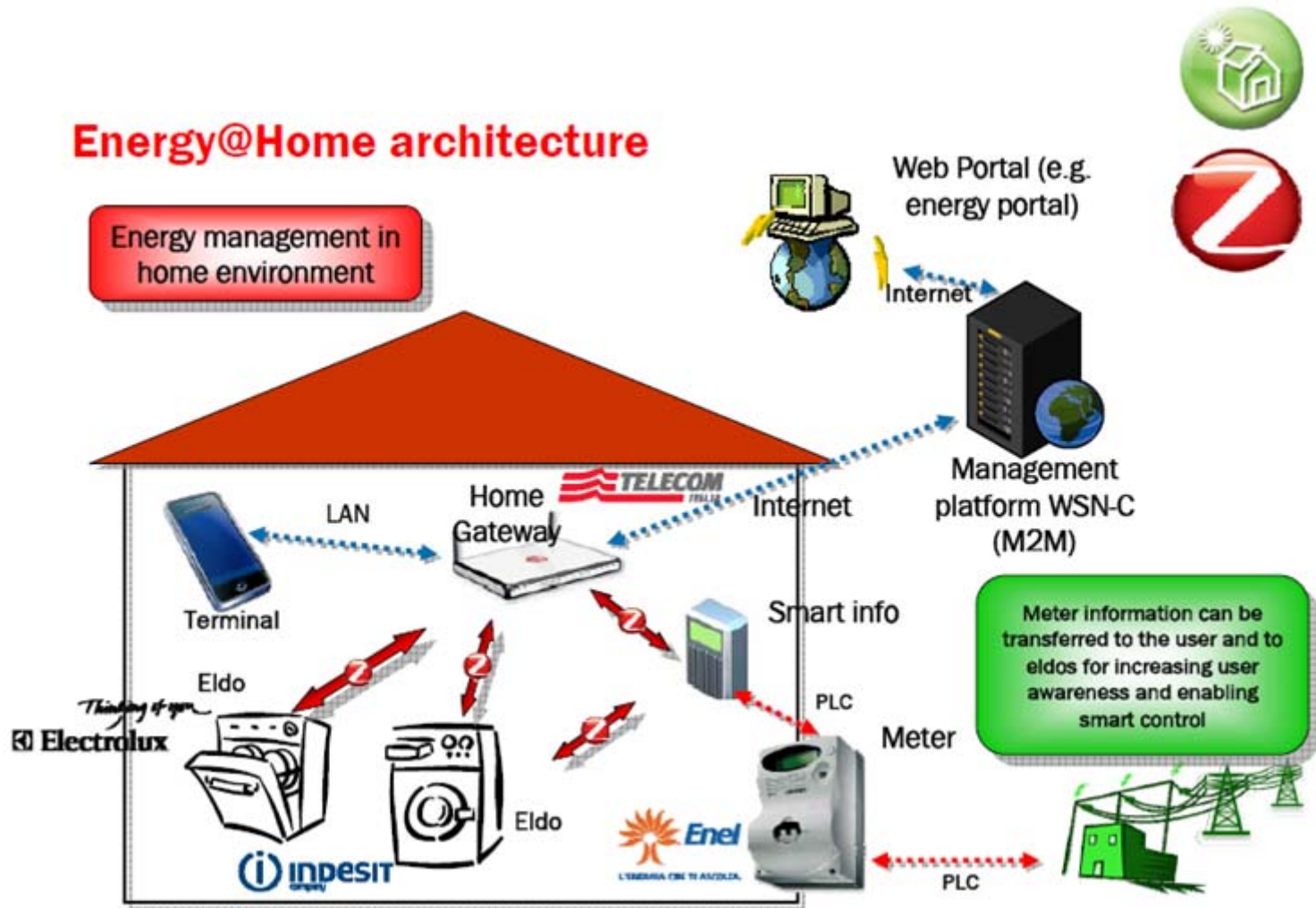

What about other countries?

Energy@Home : Press Review

Energy@Home project

29 October 2009

Energy@Home Italian project to define energy save in-home system



Open technology based on open standards

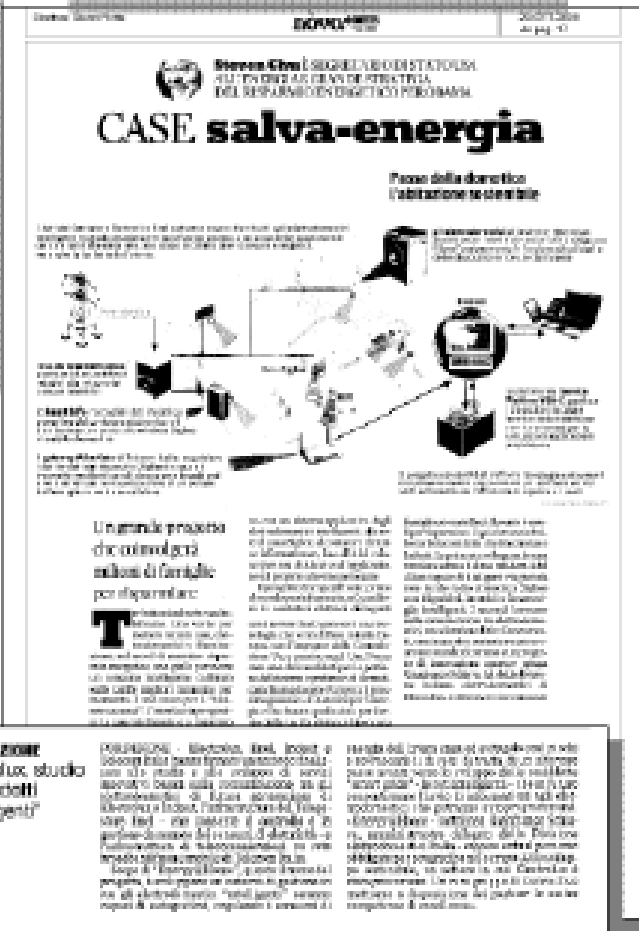

The Energy Aware House, a washer-dryer which:

- can optimize its use of green and renewable energy through a connection to Internet and to the Smart Grid: Indesit contributes to the climate change challenge!
- can suggest the user when is the best time to use it, thus helping her/him to save money.
- can educate its user giving her/him awareness of its energy consumption and its cost, to reach easily the 5-10% target of energy use reduction.

The same concept could be readily applied to other Indesit appliances..



Smart Appliances Projects: Dynamic Demand Control

Indesit Company, RLtec and Npower roll out Europe's biggest trial of smart fridges

- The dynamic demand technology developed by RLtec and Indesit research teams helps to maintain the balance between supply and demand across the national electricity grid.
- From this month and through 2010, up to 3,000 UK Npower customers will be supplied with Indesit Company dynamic demand fridges and fridge freezers, free of charge, in what will be world's first residential test of the technology.

RLtec
Smart Grid solutions

 **INDESIT**
company





Future Concepts: A New Vision...

System concept: main components

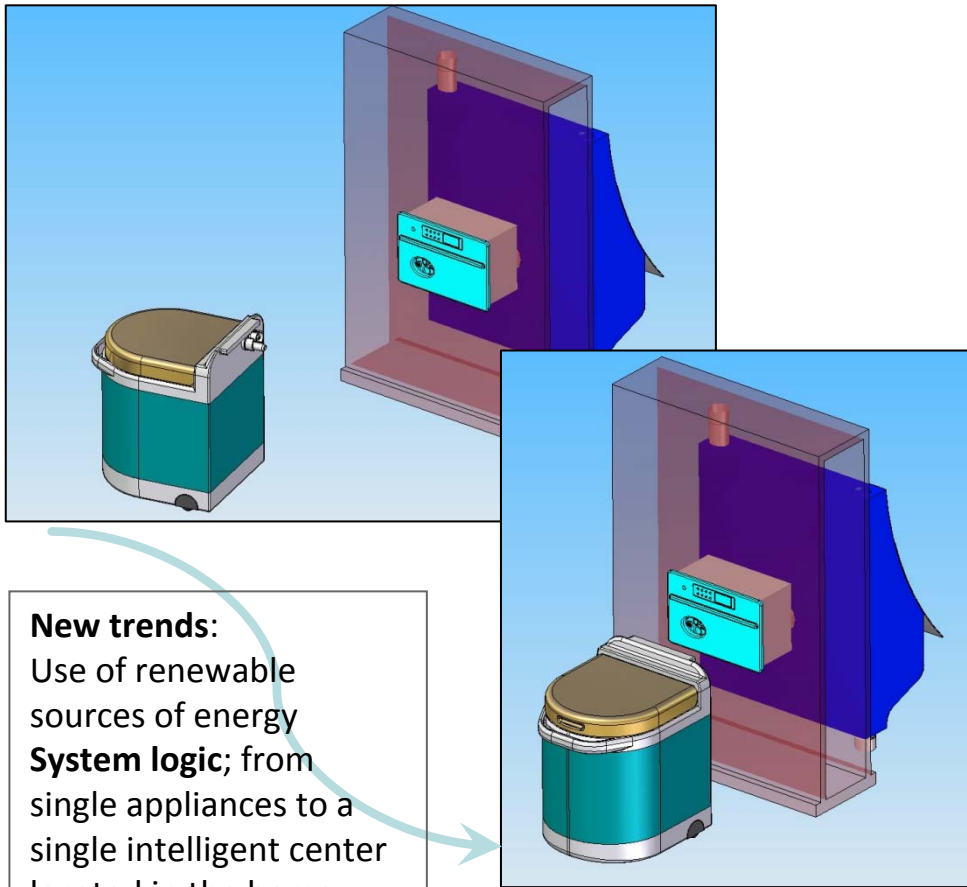

New trends:
Use of renewable sources of energy
System logic; from single appliances to a single intelligent center located in the home;
Breakthrough opportunities

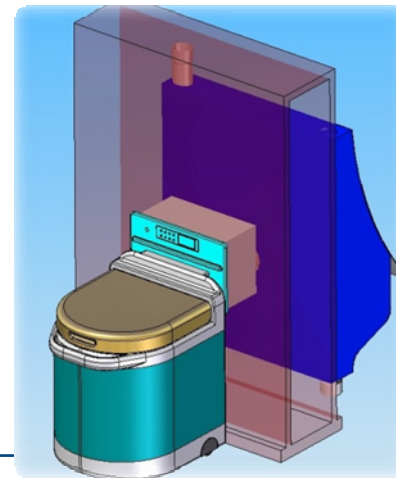
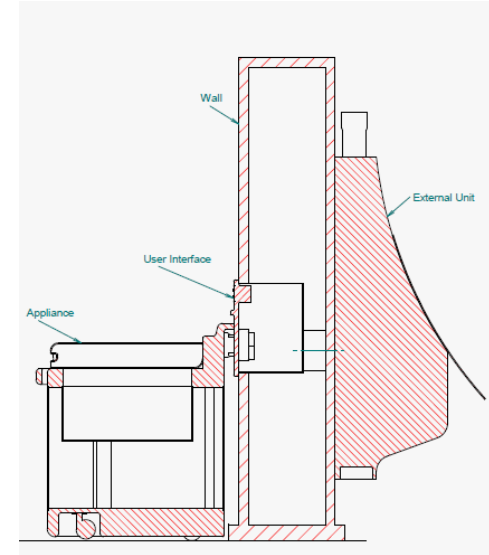
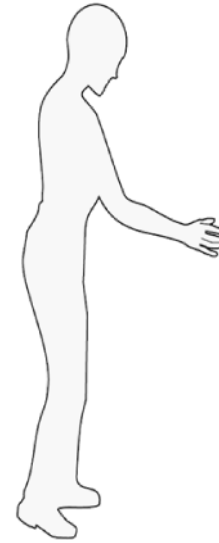

...Made for a Total Flexibility!

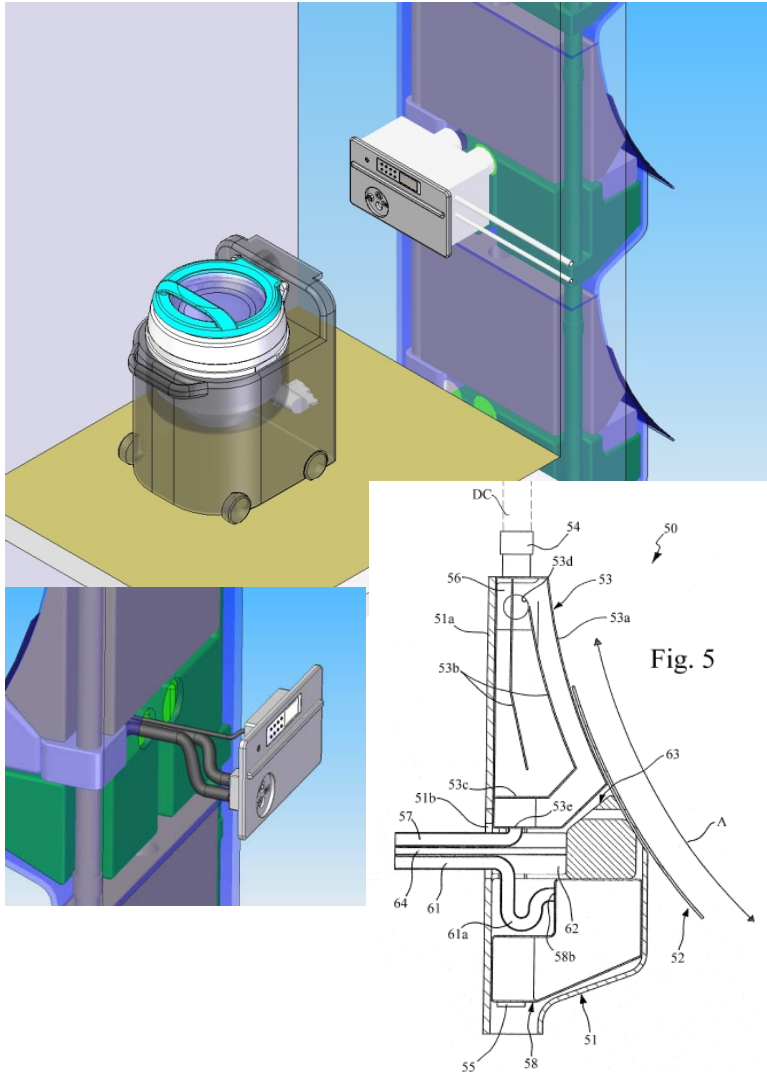

Activity Target (All electrical appliances)

■ *Development of washing machine, dishwasher...*

Expected benefits (Main Performances):

- *Energy: 50% from renewable sources*
- *Water : 50% from rainfall*

Expected benefits (Side Performances):

- *Ergonomy, Flexibility*
- *Savings: lighter, modular product structures...*

Technical Risk

- *Impact on buldings*



**L'efficienza energetica e l'integrazione
degli elettrodomestici**

Presenter: Paolo Faraldi

ANIE

Milan – December, 18th 2009